

J. CALVO 
siéntate, siéntete único

Desde 1976

J. CALVO 



**Constancia
creatividad
calidad**

Constancy
creativity
quality

Constance
créativité
qualité

Constância
criatividade
qualidade

El arte de fabricar con diseño

The art of manufacturing with design
L'art de fabriquer avec le design
A arte de fabricar com design

The perfect combination of tradition and technology

to offer the best results in design and comfort

It is the concept with which we try to synthesize the philosophy of our company for the creation of personalized chairs. Balance between imagination and reason, total commitment to quality and functionality without giving up the concept of furniture that defines you.

J. CALVO forged its origin from the concern and passion for furniture of its founder and still president José Antonio Calvo López. At present, this solid and projected firm dedicates 30% of its manufacturing to export, never forgetting the national market of which J. CALVO is a reference today.

L'alliance parfaite de la tradition et de la technologie

pour offrir les meilleurs résultats en matière de design et de confort

C'est le concept avec lequel nous essayons de synthétiser la philosophie de notre entreprise pour la création de chaises personnalisées. Équilibre entre imagination et raison, engagement total envers la qualité et la fonctionnalité sans renoncer au concept de mobilier qui vous définit.

J. CALVO a forgé son origine du souci et de la passion pour le mobilier de son fondateur et toujours président José Antonio Calvo López. A l'heure actuelle, cette entreprise solide et projetée consacre 30% de sa fabrication à l'export, sans oublier le marché national dont J. CALVO est aujourd'hui une référence.

A combinação perfeita de tradição e tecnologia

para oferecer os melhores resultados em design e conforto

É o conceito com o qual procuramos sintetizar a filosofia da nossa empresa para a criação de cadeiras personalizadas. Equilíbrio entre imaginação e razão, aposta total na qualidade e funcionalidade sem abrir mão do conceito de mobiliário que o define.

A J. CALVO nasceu da preocupação e paixão pelo mobiliário de seu fundador e ainda presidente José Antonio Calvo López. Actualmente, esta sólida e projectada empresa dedica 30% do seu fabrico à exportação, nunca esquecendo o mercado nacional no qual a J. CALVO é hoje uma referência.

J. CALVO

siéntate, siéntete único

Desde 1976

La perfecta combinación entre tradición y tecnología

para ofrecer los mejores resultados en diseño y comodidad

Es el concepto con el cual intentamos sintetizar la filosofía de nuestra empresa para la creación de sillas personalizadas. Equilibrio entre imaginación y razón, compromiso total con la calidad y la funcionalidad sin renunciar al concepto de mueble que te define. J. CALVO forjó su origen desde la inquietud y pasión por el mueble de su fundador y todavía presidente José Antonio Calvo López. En la actualidad esta firma sólida y con proyección, dedica un 30% de su fabricación a la exportación, sin olvidarse nunca del mercado nacional del cual J.CALVO a día de hoy es referencia.

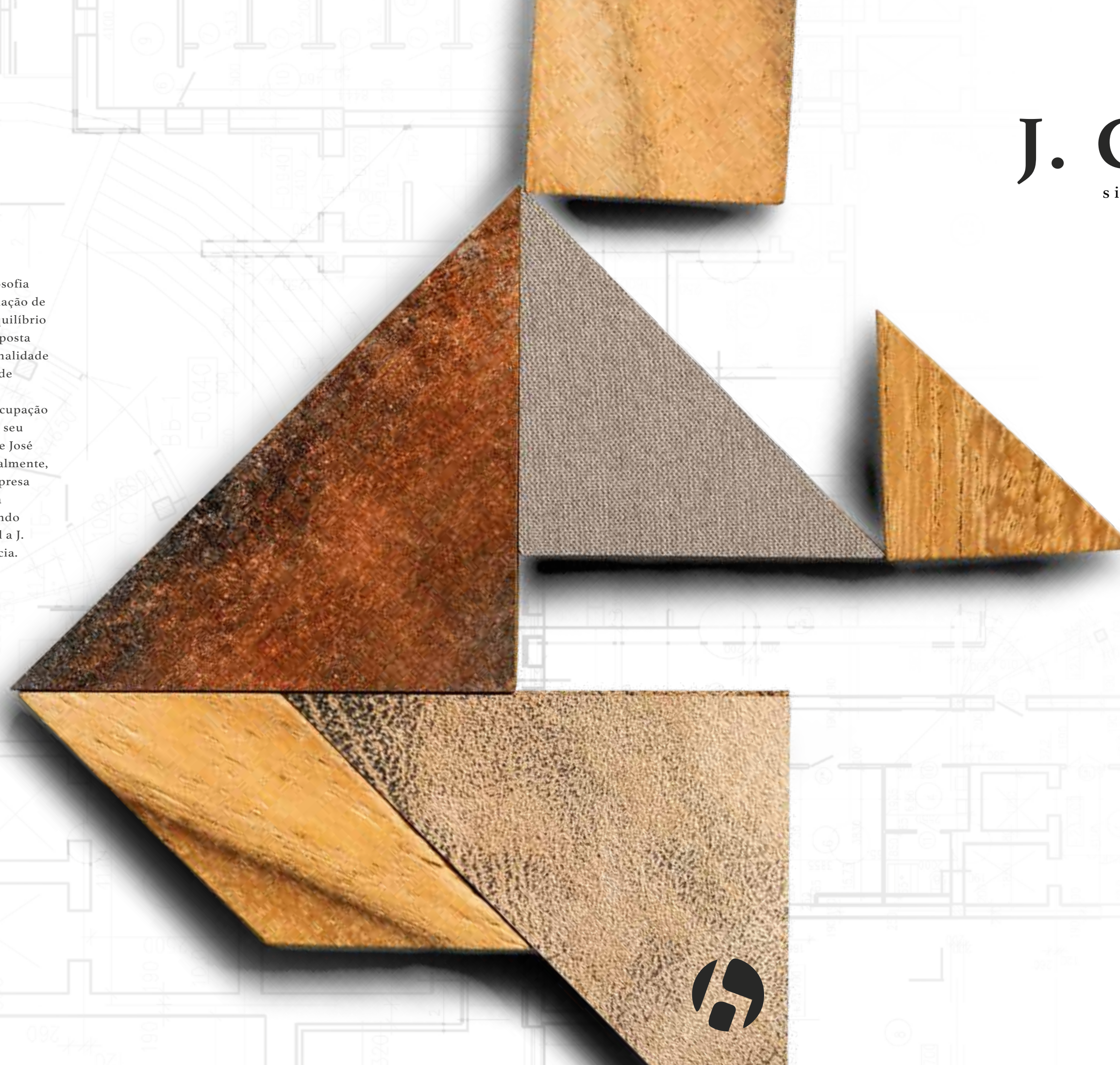

Artesanía y tradición

Crafts and tradition / Artisanat et tradition / Artesanato e tradição



Equipo humano experimentado

Experienced human team
Équipe humaine expérimentée
Equipe humana experiente



Selección de las mejores materias primas

Selection of the best raw materials
Sélection des meilleures matières premières
Seleção das melhores matérias-primas



La artesanía y el trabajo manual cuidando el más mínimo detalle

Craftsmanship and manual work taking care of the smallest detail
Artisanat et travail manuel soigné dans les moindres détails
Artesanato e trabalho manual cuidando dos menores detalhes

Tecnología y diseño

Technology and design / Technologie et conception / Tecnologia e design



Departamento de diseño

Design department
Département artistique
Departamento de design



Sistemas de producción de última generación

State-of-the-art production systems
Des systèmes de production à la pointe de la technologie
Sistemas de produção de última geração



Atención al cliente

Customer Support
Attention au client
Suporte ao cliente

J. CALVO



siéntate, siéntete único

CONFIANZA TOTAL

TOTAL CONFIDENCE / CONFIANCE TOTALE / CONFIANÇA TOTAL



PROYECTOS A MEDIDA
CUSTOM PROJECTS
PROJETS SUR MESURE
PROJETOS PERSONALIZADOS















































SOLUCIONES CONTRACT
CONTRACT SOLUTIONS
SOLUTIONS CONTRACTUELLES
SOLUÇÕES DE CONTRATO



EL HOGAR A TU ALCANCE
HOME WITHIN YOUR REACH
LA MAISON À VOTRE PORTÉE
CASA DENTRO DO SEU ALCANCE

ALAMO pag. 14/17	 Alamo Silla	 Alamo Sillón	LYSSA pag. 18/21	 Lyssa 85-Lyssa 95	HUGO pag. 22/27	 Hugo Silla	 Hugo Sillón	 Hugo ND Silla	 Hugo ND Sillón	 Hugo MT2 Silla	 Hugo MT2 Sillón	ASIA pag. 28/33	 Asia Silla	 Asia Sillón	 Asia ND Silla	 Asia ND Sillón	 Asia MT2 Silla	 Asia MT2 Sillón					
ENZO pag. 34/37	 Enzo MT	 Enzo GMT	IDRA pag. 38/41	 Idra	 Idra ND	 Idra MT2	DIMA pag. 42/45	 Dima ND	 Dima MT2	MÓNACO pag. 46/49	 Mónaco ND	 Mónaco PMT	DALIA pag. 50/53	 Dalia ND	 Dalia PMT	DAKOTA pag. 54/57	 Dakota ND	 Dakota MT					
SINTRA pag. 58/61	 Sintra Silla	 Sintra Sillón	LARA pag. 62/65	 Lara	 Lara ND	 Lara MT	CONDOR pag. 66/69	 Condor	DENVER LONDRES PRESTON pag. 70/75	 Denver	 Londres	 Preston	BOSTON pag. 76/79	 Boston	IBIZA TOKIO pag. 80/83	 Ibiza	 Tokio	DALLAS pag. 84/87	 Dallas				
ISABELLA pag. 88/91	 Isabella	KARLA BELLA pag. 92/95	 Karla	 Bella 95- Bella 105	MILÁN pag. 96/99	 Milán	OSLO pag. 100/103	 Oslo	 Oslo ND	 Oslo MT	CATANIA TREVI pag. 104/107	 Catania	 Trevi	VENECIA pag. 108/111	 Venecia FC 90	 Venecia 90	 Venecia FC 100	 Venecia 100	FLORENCIA GÉNOVA pag. 112/115	 Florescia L	 Génova L	 Florescia XL	 Génova XL
CARMELA pag. 116/119	 Carmela	BALI pag. 120/123	 Bali	 Bali ND	 Bali MT	LORETT pag. 124/127	 Lorett	84-99	DORA pag. 128/131	 Dora	TORINO pag. 132/135	 Torino	 TorinoND	 Torino MT	LUXE pag. 136/139	 Luxe	 Luxe CR	GIO pag. 140/143	 Gio	 Gio ND	 Gio MT		
NÁPOLES pag. 144/147	 Napoles 84	JULIETA pag. 148/151	 Napoles 99	JULIETA	MARINA pag. 152/155	 Marina	 Marina ND	 Marina MT	CASTILLA pag. 156/159	 Castilla	SILICIA pag. 160/163	 Sicilia	 Sicilia ND	 Silicia MT	VERONA MARSELLA pag. 164/167	 Verona	 Marsella	CANCÚN pag.168/171	 Cancún	 Cancún ND	 Cancún MT		

<p>VIENA</p>  <p>pag. 172/175</p> <p>Viena 90 Viena 100</p>	<p>ALEX</p>  <p>pag. 176/179</p> <p>Alex Alex ND Alex MT</p>	<p>MADEIRA LISBOA</p>  <p>pag. 180/183</p> <p>Madeira Silla Madeira Sillón Lisboa Silla Lisboa Sillón</p>	<p>SOFIA</p>  <p>pag. 184/187</p> <p>Sofia Sofia MT</p>	<p>VICTORIA</p>  <p>pag. 188/191</p> <p>Victoria</p>	<p>SENA</p>  <p>pag. 192/195</p> <p>Sena</p>	<p>IZÁN</p>  <p>pag. 196/199</p> <p>Izán</p>
<p>ALHAMBRA PERSIA OPORTO</p> <p>pag. 200/203</p>  <p>Alhambra ND P4 60-80-100</p>  <p>Persia P1 60-80-100</p>  <p>Persia P5 90-110-130</p>	<p>DEXTER OSLO</p> <p>pag. 204/207</p>  <p>Dexter 2.0 Taburete H60-H80</p>  <p>Oslo Taburete H60-H80</p>  <p>Oslo MT Taburete H60-H80</p>	<p>NEO LARA</p> <p>pag. 208/211</p>  <p>Neo Taburete H60-H80</p>  <p>Neo MT Taburete H60-H80</p>  <p>Lara Taburete H60-H80</p>  <p>Lara MT Taburete H60-H80</p>	<p>PRESTÓN VIENA</p> <p>pag. 212/215</p>  <p>Prestón Taburete H60-H80</p>  <p>Prestón MT Taburete H60-H80</p>  <p>Viena Taburete H60-H80</p>  <p>Viena MT Taburete H60-H80</p>			
<p>PUFFS</p> <p>pag. 216/217</p>  <p>Basic C</p>  <p>Basic R</p>	<p>COJINES</p> <p>pag. 218/219</p>  <p>Cuadrado</p>  <p>Redondo</p>  <p>Rectangular</p>	<p>CAPRI</p> <p>pag. 220/221</p>  <p>Capri 40</p>  <p>Capri 50</p>	<p>INDO</p> <p>pag. 222/223</p>  <p>Indo</p>	<p>TEMPO</p> <p>pag. 224/229</p>  <p>Tempo comedor</p>  <p>Tempo centro</p>	<p>MANHATTAN</p> <p>pag. 230/233</p>  <p>Manhattan</p>	
<p>PRAGA</p> <p>pag. 234/235</p>  <p>Praga comedor</p>	<p>ATLANTA</p> <p>pag. 236/237</p>  <p>Atlanta comedor</p>	<p>AREN</p> <p>pag. 238/243</p>  <p>Aren comedor</p>  <p>Aren centro</p>	<p>DUBAI</p> <p>pag. 244/249</p>  <p>Dubai comedor</p>  <p>Dubai centro</p>	<p>BERLÍN</p> <p>pag. 250/255</p>  <p>Berlín comedor</p>  <p>Berlín centro</p>		
<p>MOSCÚ</p> <p>pag. 256/261</p>  <p>Moscú comedor</p>  <p>Moscú centro</p>	<p>ROMA</p> <p>pag. 262/267</p>  <p>Roma comedor</p>  <p>Roma centro</p>	<p>OPCIONES OPTIONS OPCIONES OPÇÕES</p> <p>A</p> <p>pag. 6</p>	<p>OPCIONES OPTIONS OPCIONES OPÇÕES</p> <p>B</p> <p>pag. 267</p>	<p>COLORES DE FABRICANTES MANUFACTURER COLORS COULEURS DU FABRICANT CORES DO FABRICANTE</p> <p>pag. 268</p>	<p>LISTADO DE TELAS LIST OF FABRICS LISTE DE TISSU LISTA DE TECIDOS</p> <p>pag. 268/269</p>	

ÁLAMO



ÁLAMO SILLA

Álamo silla y Álamo sillón piezas con gran riqueza y artesanía en su diseño, construido con técnicas tradicionales para conseguir una agradable estética.

Alamo chair and Alamo armchair pieces with great richness and craftsmanship in their design, built with traditional techniques to achieve a pleasant aesthetic.



ÁLAMO SILLÓN

La chaise Alamo et le fauteuil lamo sont des pièces d'une grande richesse et d'un savoir-faire artisanal dans leur conception, construites avec des techniques traditionnelles pour obtenir une esthétique agréable.

Cadeira Alamo e poltrona Alamo peças com grande riqueza e acabamento no seu design, construídas com técnicas tradicionais para atingir uma estética agradável.



ÁLAMO SILLÓN

Color / Colour / Couleur / Cor:
NEGRO VIEJO
Tela / Fabric / Tissu / Tecido:
XIA 05 - S/B STILO TEXTIL

INDO CENTRO

Mesa de centro / Coffee table
Table basse / Mesa de centro
Color / Colour / Couleur / Cor:
BLANCO MATE 316 J.C.
PATAS ROBLE 368 J.C.

ÁLAMO
SILLA
SILLÓN

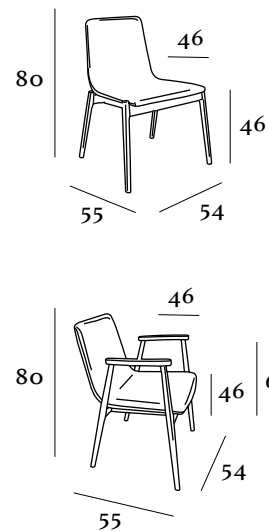

Barnizado, lacado
o color muestra

Varnished, lacquered or sample colour
Vernissage laqué ou couleur de l'échantillon
Envernizamento, lacagem ou cor da amostra

	TC	SA	SB	SC	SD
SILLA	342	361	381	401	421
SILLÓN	376	395	415	435	455

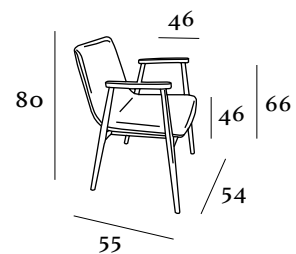

	x1 silla	x1 silla	x2 sillas	x2 sillas
SILLA	1,00 m.	5,80 kg.	14 kg.	0,44 m ³
SILLÓN	1,00 m.	6,20 kg.	14,9 kg.	0,54 m ³



ÁLAMO SILLÓN

Color / Colour / Couleur / Cor:
NEGRO VIEJO
Tela / Fabric / Tissu / Tecido:
XIA 05

OPCIONES (en puntos) / OPTIONS (points) / OPTIONS (points) / OPÇÕES (pontos)

3 + 0 | 5 + 10 | 6 + 25 | 7 + 10 | 9 + 30 | 10 + 25 | 11 + 60 | 13 + 90
Por unidad | Por unidad | Por unidad | Por unidad | Por unidad | Por unidad | Por unidad | Por unidad

ÁLAMO SILLA

Color / Colour / Couleur / Cor:
NEGRO VIEJO
Tela / Fabric / Tissu / Tecido:
XIA 05

LYSSA



LYSSA 85

Confort , diseño y posibilidad definen a Lyssa 85-95 con un valor añadido ya que esta disponible en dos alturas, con el fin de ocupar un lugar en cualquier ambiente.

Comfort, design and possibility define the Lyssa 85-95 with added value since it is available in two heights, in order to occupy a place in any environment.



LYSSA 95

Confort, design et possibilité définissent le Lyssa 85-95 avec une valeur ajoutée puisqu'il est disponible en deux hauteurs, afin d'occuper une place dans n'importe quel environnement.

Conforto, design e possibilidade definem o Lyssa 85-95 com valor acrescentado, uma vez que está disponível em duas alturas, para ocupar um lugar em qualquer ambiente.



LYSSA 95
Color / Colour / Couleur / Cor:
300 J.C.
Tela / Fabric / Tissu / Tecido:
LIDO 03 - VIVO LIDO 07 - S/B FROCA

LYSSA 85
LYSSA 95

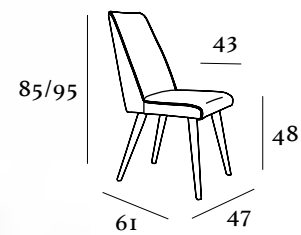

Barnizado, lacado
o color muestra

Varnished, lacquered or sample colour
Vernissage laqué ou couleur de l'échantillon.
Envernizamento, lacagem ou cor da amostra

TC	SA	SB	SC	SD
275	295	315	335	355

x1 sillas	x1 silla	x2 sillas	x2 sillas
1,50 m.	7,50 kg.	17,5 kg.	0,44 m ³

OPCIONES (en puntos) / OPTIONS (points) / OPTIONS (points) / OPÇÕES (pontos)

3 + 0	5 + 10	6 + 25	7 + 10	9 - 30	11 + 60
	Por unidad	Por unidad	Por unidad		
13 + 90	14 GND + 125	15 + 0	16 ND + 0	17 + 0	
	GMT	BASE PMT	NDP4 + 33	BASE MT	

LYSSA 95

Color / Colour / Couleur / Cor:

300 J.C.

Tela / Fabric / Tissu / Tecido:

CORUM 04 BLANCO - VIVO LIDO 03 - S/B FROCA

LYSSA 95

Color / Colour / Couleur / Cor:

300 J.C.

Tela / Fabric / Tissu / Tecido:

LIDO 03 - VIVO LIDO 07 - S/B FROCA

HUGO



HUGO SILLA

HUGO SILLÓN

HUGO ND SILLA

HUGO ND SILLÓN

HUGO MT₂ SILLA

HUGO MT₂ SILLÓN

Funcional, elegante, con carácter. Su comodidad y posibilidades de acabados hacen de la familia Hugo una buena opción para equipar cualquier ambiente.

Functional, elegant, with character. Its comfort and possibilities of finishes make the Hugo family a good option to equip any environment.

Fonctionnel, élégant, de caractère. Son confort et ses possibilités de finitions font de la famille Hugo une bonne option pour équiper n'importe quel environnement.

Funcional, elegante e com personalidade. O seu conforto e possibilidades de acabamentos fazem da família Hugo uma boa opção para equipar qualquer ambiente.



HUGO SILLÓN

Color / Colour / Couleur / Cor: BLANCO 316 MATE J.C.
Tela / Fabric / Tissu / Tecido: BLUE REIG - S/B CURDEC

DUBAI CENTRO - CHAPA ROBLE NATURAL

Mesa de centro / Coffee table / Table basse / Mesa de centro
Color / Colour / Couleur / Cor: TAPA ROBLE 680
PATAS + PORTERÍA - BLANCO MATE 316 J.C.

HUGO
SILLA
SILLÓN

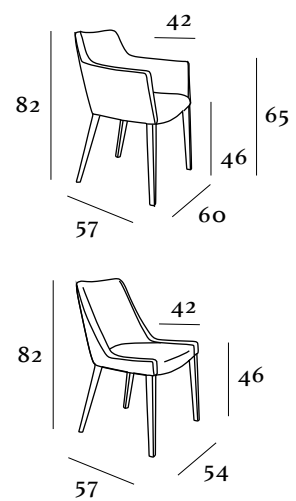

Barnizado, lacado
o color muestra
Varnished, lacquered or sample colour
Vernissage laqué ou couleur de l'échantillon.
Envernizamento, lacagem ou cor da amostra

	TC	SA	SB	SC	SD
SILLA	288	308	328	348	368
SILLÓN	322	342	362	382	402

SILLA	x1 unid. 1,60 m.	x1 unid. 7,10 kg.	x2 unids. 16,7 kg.	x2 unids. 0,43 m ³
SILLÓN	1,80 m.	7,70 kg.	17,9 kg.	0,54 m ³

OPCIONES (en puntos) / OPTIONS (points) / OPTIONS (points) / OPÇÕES (pontos)

- 1 + 33 Patas: 4 | 3 + 0 | 5 + 10 Por unidad | 6 + 25 Por unidad | 7 + 10 Por unidad | 9 + 30 | 10 + 25 | 13 + 90

HUGO SILLA
Color / Colour / Couleur / Cor: **ROBLE 680 J.C.**
Tela / Fabric / Tissu / Tecido:
MYSTIC 324 TRASERA LANCELORT 02
S/C AQUA CLEAN / FROCA



HUGO SILLÓN
Color / Colour / Couleur / Cor: **306 J.C.**
Tela / Fabric / Tissu / Tecido:
MADONE AGUA MARINA - S/B C&O

HUGO
SILLA MT2
SILLÓN MT2

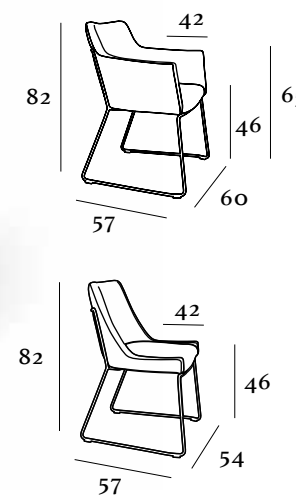

Acabados patas metal
Metal legs finishes
Negro epoxi Blanco epoxi Cromo Oro epoxi

	TC	SA	SB	SC	SD
SILLA	342	361	381	401	421
SILLÓN	376	395	415	435	455

SILLA	x1 unid. 1,60 m.	x1 unid. 11,2 kg.	x2 unids. 24,9 kg.	x2 unids. 0,43 m ³
SILLÓN	1,80 m.	11,5 kg.	25,5 kg.	0,54 m ³

OPCIONES (en puntos) / OPTIONS (points) / OPTIONS (points) / OPÇÕES (pontos)

- 3 + 0 | 5 + 10 Por unidad | 6 + 25 Por unidad | 7 + 10 Por unidad | 9 + 30 | 10 + 25

HUGO SILLÓN MT2
Color / Colour / Couleur / Cor: **NEGRO EPOXI**
Tela / Fabric / Tissu / Tecido:
INDIGO 06 ASIENTO Y TRASERA LACELOT 06 - S/B LOMAR / FROCA



HUGO SILLA MT2
Color / Colour / Couleur / Cor: **NEGRO EPOXI**
Tela / Fabric / Tissu / Tecido:
ZEUS O4 ASIENTO BALENCIAGA 02 - S/B FROCA

HUGO
SILLA ND
SILLÓN ND

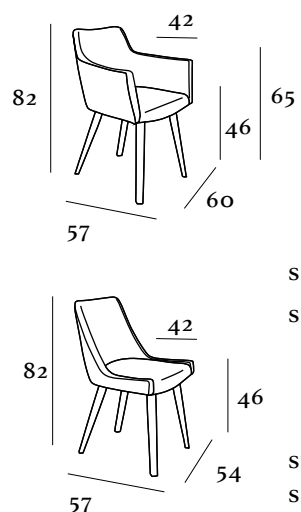

Barnizado, lacado
o color muestra
Varnished, lacquered or sample colour
Vernissage laqué ou couleur de l'échantillon.
Envernizamento, lacagem ou cor da amostra

	TC	SA	SB	SC	SD
SILLA	288	308	328	348	368
SILLÓN	322	342	362	382	402

	x1 unid.	x1 unid.	x2 unids.	x2 unids.
SILLA	1,60 m.	9,1 kg.	20,7 kg.	0,43 m ³
SILLÓN	1,80 m.	9,7 kg.	21,9 kg.	0,54 m ³

OPCIONES (en puntos) / OPTIONS (points) / OPTIONS (points) / OPÇÕES (pontos)

3 + 0	5 + 10	6 + 25	7 + 10	9 + 30	10 + 25
	Por unidad	Por unidad	Por unidad		
13 + 90	14 GND + 125	15 + 0	16 ND + 0		
	GMT + 185	PMT	NDP4 + 33		



HUGO SILLÓN ND

Color / Colour / Couleur / Cor:
ROBLE 680 J.C.

Tela / Fabric / Tissu / Tecido:
INDIGO 06 - ASIENTO Y TRASERA LACELOT 06 - S/B FROCA

HUGO SILLA ND

Color / Colour / Couleur / Cor:
VULCANO TEX J.C.

Tela / Fabric / Tissu / Tecido:
ZEUS O4 - ASIENTO BALENCIAGA 02 - S/B FROCA

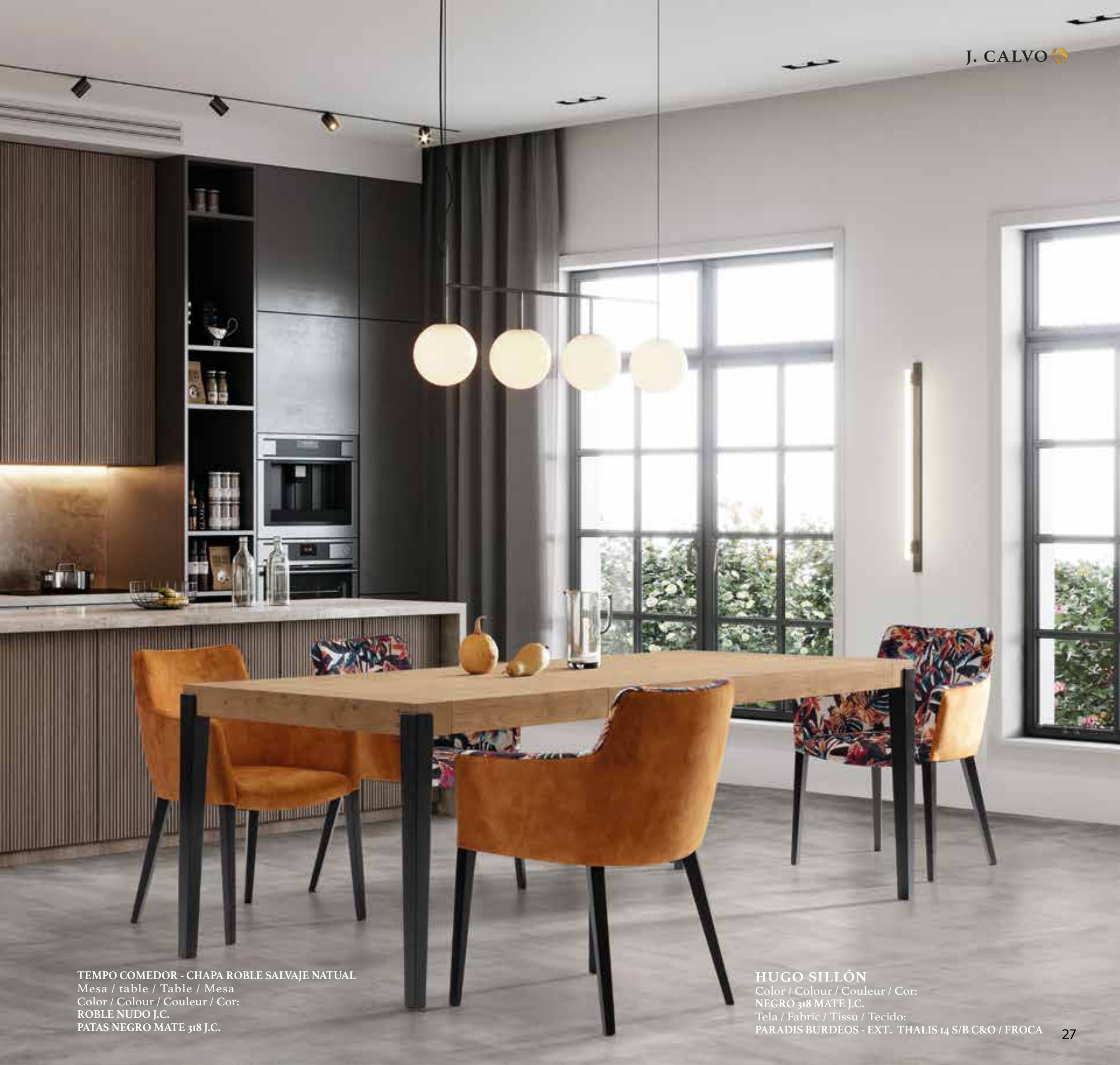

TEMPO COMEDOR - CHAPA ROBLE SALVAJE NATURAL
Mesa / table / Table / Mesa
Color / Colour / Couleur / Cor:
ROBLE 680 J.C.
Tela / Fabric / Tissu / Tecido:
ROBLE NUDO J.C.
PATAS NEGRO MATE 318 J.C.

HUGO SILLÓN
Color / Colour / Couleur / Cor:
NEGRO 318 MATE J.C.
Tela / Fabric / Tissu / Tecido:
PARADIS BURDEOS - EXT. THALIS 14 S/B C&O / FROCA

ASIA



ASIA SILLA

ASIA SILLÓN

ASIA ND SILLA

ASIA ND SILLÓN

ASIA MT2 SILLA

ASIA MT2 SILLÓN

Su diseño en líneas curvas la convierten en una estupenda y original opción. El punto fuerte de esta gama es su flexibilidad decorativa y su ligereza de líneas.

Its curved design makes it a great and original option. The strong point of this range is its decorative flexibility and its lightness of lines.

Son design incurvé en fait une option géniale et originale. Le point fort de cette gamme est sa souplesse décorative et sa légèreté de lignes.

Seu design curvo o torna uma opção excelente e original. O ponto forte desta gama é a flexibilidade decorativa e a leveza das linhas.



CAPRI 50 AUXILIAR - CHAPA ROBLE NATURAL
Mesa auxiliar / Side table
Table basse / Tabela auxiliar
Color / Colour / Couleur / Cor:
ROBLE 680 J.C.

ASIA SILLÓN
Color / Colour / Couleur / Cor:
ROBLE 680 J.C.
Tela / Fabric / Tissu / Tecido:
THALIS 19 - S/B FROCA

ASIA SILLA
ASIA SILLÓN

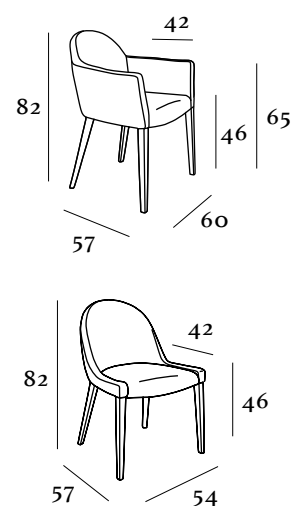

Barnizado, lacado
o color muestra
*Varnised, lacquered or sample colour
Vernissage laqué ou couleur de l'échantillon.
Envernizamento, lacagem ou cor da amostra*

	TC	SA	SB	SC	SD
SILLA	288	308	328	348	368
SILLÓN	322	342	362	382	402

	x1 unid.	x1 unid.	x2 unids.	x2 unids
SILLA	1,60 m.	7,10 kg.	16,7 kg.	0,43 m ³
SILLÓN	1,80 m.	7,70 kg.	17,9 kg.	0,54 m ³

OPCIONES (en puntos) / OPTIONS (points) / OPTIONS (points) / OPÇÕES (pontos)

- 1 + 33
Patás: 4
- 3 + 0
- 5 + 10
Por unidad
- 6 + 25
Por unidad
- 7 + 10
Por unidad
- 9 + 30
- 10 + 25
- 13 + 90



ASIA SILLÓN
Color / Colour / Couleur / Cor:
ROBLE 68o J.C.
Tela / Fabric / Tissu / Tecido:
THALYS 19

ASIA
SILLA ND
SILLÓN ND

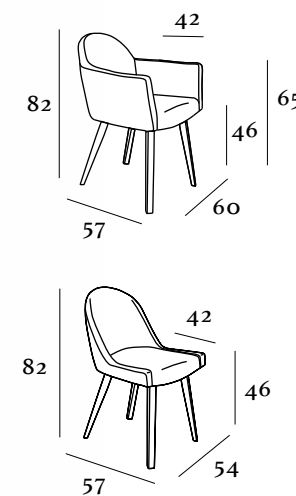

Barnizado, lacado
o color muestra
*Varnised, lacquered or sample colour
Vernissage laqué ou couleur de l'échantillon.
Envernizamento, lacagem ou cor da amostra*

	TC	SA	SB	SC	SD
SILLA	288	308	328	348	368
SILLÓN	322	342	362	382	402

	x1 unid.	x1 unid.	x2 unids.	x2 unids
SILLA	1,60 m.	9,1 kg.	20,7 kg.	0,43 m ³
SILLÓN	1,80 m.	9,7 kg.	21,9 kg.	0,54 m ³

OPCIONES (en puntos) / OPTIONS (points) / OPTIONS (points) / OPÇÕES (pontos)

- 3 + 0
- 5 + 10
Por unidad
- 6 + 25
Por unidad
- 7 + 10
Por unidad
- 9 + 30
- 10 + 25
- 13 + 90
- 14 GND + 125
GMT + 185
- 15 + 0
PMT
- 16 ND + 0
NDP4 + 33



ASIA ND SILLÓN
Color / Colour / Couleur / Cor:
ROBLE 68o J.C.
Tela / Fabric / Tissu / Tecido:
ELIOS 7o - S/B C&O

ASIA
SILLA MT₂
SILLÓN MT₂

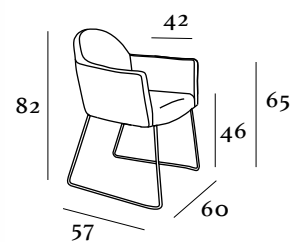

Acabados patas metal

Metal legs finishes



TC SA SB SC SD

SILLA 342 361 381 401 421

SILLÓN 376 395 415 435 455

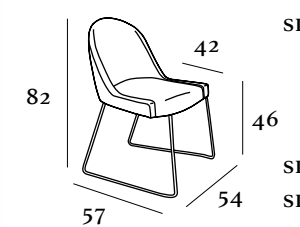

	x1 unid.	x1 unid.	x2 unids.	x2 unids.
SILLA	1,60 m.	11,2 kg.	24,9 kg.	0,43 m ³
SILLÓN	1,80 m.	11,5 kg.	25,5 kg.	0,54 m ³



ASIA SILLA MT₂

Color / Colour / Couleur / Cor:

NEGRO EPOXI

Tela / Fabric / Tissu / Tecido:
ELIOS 70 - S/B C&O

OPCIONES (en puntos) / OPTIONS (points) / OPTIONS (points) / OPÇÕES (pontos)

3 + 0 | 5 + 10 | 6 + 25 | 7 + 10 | 9 + 30 | 10 + 25
Por unidad | Por unidad | Por unidad | Por unidad | Por unidad | Por unidad

ASIA SILLÓN MT₂

Color / Colour / Couleur / Cor:

NEGRO EPOXI

Tela / Fabric / Tissu / Tecido:
ELIOS 70 - S/B C&O



ENZO



ENZO

Un concepto diferente y práctico, donde se combinan líneas curvas con sutiles rasgos rectos Enzo es un sillón con personalidad.

A different and practical concept, where curved lines are combined with subtle straight features. Enzo is an armchair with personality.



ENZO GMT

Un concept différent et pratique, où les lignes courbes se conjuguent à de subtils traits rectilignes, Enzo est un fauteuil qui a de la personnalité.

Um conceito diferente e prático, onde linhas curvas se combinam com traços retos sutis Enzo é uma poltrona com personalidade.



ENZO GMT

Color / Colour / Couleur / Cor:

NEGRO EPOXI

Tela / Fabric / Tissu / Tecido:

BRUNEI 05 - ASIENTO PICASSO ANTRACITA - S/B FROCA / C&O

ENZO
ENZO GMT

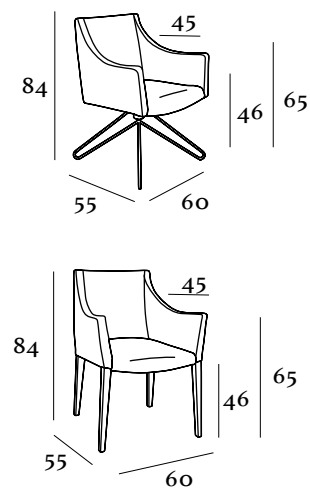

Acabados patas metal

Metal legs finishes



Negro epoxi Blanco epoxi Cromo Oro epoxi

Barnizado, lacado o color muestra

Varnished, lacquered or sample colour
Vernissage laqué ou couleur de l'échantillon.
Envernizamento, lacagem ou cor da amostra

TC SA SB SC SD

ENZO	322	342	362	382	402
GMT	507	527	547	567	587

	x1 unid.	x1 unid.	x2 unids.	x2 unids.
ENZO	1,80 m.	7,7 kg.	17,9 kg.	0,54 m ³
GMT	1,80 m.	13,7 kg.	29,8 kg.	0,54 m ³



180°
Retorno

OPCIONES (en puntos) / OPTIONS (points) / OPTIONS (points) / OPÇÕES (pontos)

1 + 33	3 + 0	5 + 10	6 + 25	7 + 10	9 + 30	10 + 25
Patas: 4		Por unidad	Por unidad	Por unidad		
13 + 90	14 GND + 125	15 + 0	16 ND + 0	17 + 0		
	GMT - 185	PMT	NDP4 + 33	MT		

ENZO

Color / Colour / Couleur / Cor:

BLANCO 316 MATE J.C.

Tela / Fabric / Tissu / Tecido:

RENE ANTRACITA - ASIENTO RENE CRUDO S/B - FROCA - C&O

ENZO GMT

Color / Colour / Couleur / Cor:

NEGRO EPOXI

Tela / Fabric / Tissu / Tecido:

BRUNEI 05 - ASIENTO PICASSO ANTRACITA S/B - FROCA - C&O

IDRA



IDRA

Allá donde este Idra, enrique y aporta su peculiar estilo. Confortable, los diferentes modelos de patas y tejidos ofrecen opciones de sobra donde elegir.

Wherever Idra is, he enriches and brings his peculiar style. Comfortable, the different models of legs and fabrics offer plenty of options to choose from.



IDRA MT2

Où qu'il soit, Idra enrichit et apporte son style si particulier. Confortables, les différents modèles de pieds et de tissus offrent de nombreuses possibilités de choix.

Onde quer que Idra esteja, ele enriquece e traz seu estilo peculiar. Confortáveis, os diferentes modelos de pernas e tecidos oferecem muitas opções à sua escolha.



IDRA ND



IDRA
Color / Colour / Couleur / Cor:
BLANCO 316 MATE J.C.
Tela / Fabric / Tissu / Tecido:
ERMES 10 PINK - ASIEN TO CALIPSO 01 - S/B C&O

IDRA
IDRA ND

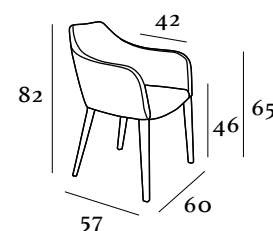

Barnizado, lacado o color muestra
Varnished, lacquered or sample colour
Vernissage laqué ou couleur de l'échantillon.
Envernizamento, lacagem ou cor da amostra

TC	SA	SB	SC	SD
322	342	362	382	402

	Icon	Unit	Weight	Volume
IDRA		x1 unid.	7,7 kg.	0,54 m ³
IDRA ND		x2 unids.	17,9 kg.	0,54 m ³

OPCIONES (en puntos) / **OPTIONS** (points) / **OPTIONS** (points) / **OPÇÕES** (pontos)

1 + 33	3 + 0	5 + 10	6 + 25	7 + 10	9 + 30	10 + 25
Patas: 4		Por unidad	Por unidad	Por unidad	Por unidad	Por unidad
13 + 90	14 GND + 125 GMT + 185	15 + 0 PMT	16 ND + 0 NDP4 + 33	17 + 0 MT		

IDRA ND
Color / Colour / Couleur / Cor:
ROBLE 680 J.C.
Tela / Fabric / Tissu / Tecido:
RAISA 04 - S/B FROCA



IDRA MT2



Acabados patas metal
Metal legs finishes

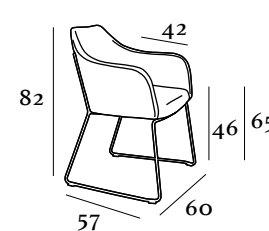

TC	SA	SB	SC	SD
376	395	415	435	455

	Icon	Unit	Weight	Volume
IDRA MT2		x1 unid.	11,5 kg.	0,54 m ³
		x2 unids.	25,5 kg.	0,54 m ³

OPCIONES (en puntos) / **OPTIONS** (points) / **OPTIONS** (points) / **OPÇÕES** (pontos)

3 + 0	5 + 10	6 + 25	7 + 10	9 + 30	10 + 25	15 + 0 PMT
Por unidad	Por unidad	Por unidad	Por unidad	Por unidad	Por unidad	

IDRA MT2
Color / Colour / Couleur / Cor:
DORADO 338-2 J.C.
Tela / Fabric / Tissu / Tecido:
RAISA 04 - S/B FROCA



DIMA



DIMA MT2

Actual, sencilla, elegante, con infinitas posibilidades. Dima se define a si misma como un modelo sencillo, agradable a la vista y sobre todo al uso.

Wherever Idra is, he enriches and brings his peculiar style. Comfortable, the different models of legs and fabrics offer plenty of options to choose from.



DIMA ND

Où qu'il soit, Idra enrichit et apporte son style si particulier. Confortables, les différents modèles de pieds et de tissus offrent de nombreuses possibilités de choix.

Onde quer que Idra esteja, ele enriquece e traz seu estilo peculiar. Confortáveis, os diferentes modelos de pernas e tecidos oferecem muitas opções à sua escolha.



DIMA MT2
Color / Colour / Couleur / Cor:
DORADO 338-2 J.C.
Tela / Fabric / Tissu / Tecido:
THALYS 06 - S/B FROÇA

DIMA MT₂
DIMA ND

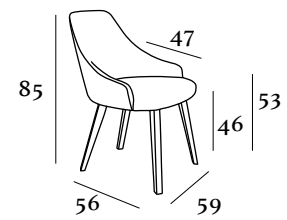
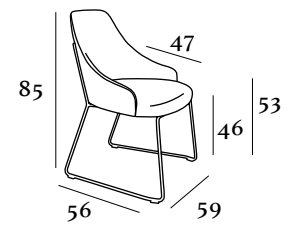

Acabados patas metal
Metal legs finishes



Barnizado, lacado
o color muestra

Varnished, lacquered or sample colour
Vernissage laqué ou couleur de l'échantillon.
Envernizamento, lacagem ou cor da amostra

TC	SA	SB	SC	SD
342	362	382	402	422

	x1 unid.	x1 unid.	x2 unids.	x2 unids
DIMA MT ₂	1,80 m.	10,0 kg.	22,5 kg.	0,44 m ³
DIMA ND	1,80 m.	11,75 kg.	26,0 kg.	0,44 m ³

OPCIONES (en puntos) / OPTIONS (points) / OPTIONS (points) / OPÇÕES (pontos)

3 + 0	4 + 65	5 + 10	6 + 25	7 + 10	9 + 30	11 + 60
	Por unidad	Por unidad	Por unidad	Por unidad		
13 + 90	14 GND + 125 GMT + 185	15 + 0 PMT	17 + 0 MT	16 ND + 0 NDP4 + 33		



DIMA MT₂

Color / Colour / Couleur / Cor:
DORADO 338-2 J.C.
Tela / Fabric / Tissu / Tecido:
THALYS 06 - S/B FROCA

MONACO



MONACO ND

Mónaco, la elegancia se transfiere al lugar donde se ubique, incluso en la dimensión más privada. Un sillón con múltiples posibilidades a su alcance.

Monaco, elegance is transferred to where it is located, even in the most private dimension. An armchair with multiple possibilities at your fingertips.



MONACO PMT

Monaco, l'élégance se transfère là où elle se trouve, même dans la dimension la plus intime. Un fauteuil aux multiples possibilités à portée de main.

Mónaco, a elegância é transferida para onde está localizada, mesmo na dimensão mais privada. Uma poltrona com múltiplas possibilidades ao seu alcance.



MONACO PMT

Color / Colour / Couleur / Cor:

NEGRO EPOXI

Tela / Fabric / Tissu / Tecido:

FUGI 01 TRASERA ROXY 03 - S/B FROCA

MONACO ND
MONACO PMT

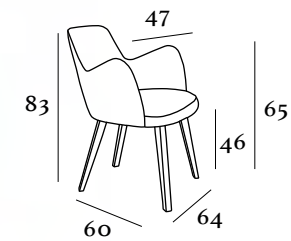
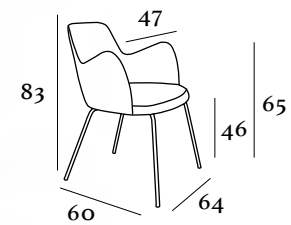

Acabados patas metal
Metal legs finishes



Barnizado, lacado
o color muestra

Varnished, lacquered or sample colour
Vernissage laqué ou couleur de l'échantillon.
Envernizamento, lacagem ou cor da amostra

	TC	SA	SB	SC	SD
	322	342	362	382	402

	x1 unid.	x1 unid.	x2 unids.	x2 unids.
ND	1,80 m.	11,25 kg.	25,0 kg.	0,54 m ³
PMT	1,80 m.	10,25 kg.	23,0 kg.	0,54 m ³

OPCIONES (en puntos) / OPTIONS (points) / OPTIONS (points) / OPÇÕES (pontos)

3 + 0	5 + 10	6 + 25	7 + 10	9 + 30	10 + 25
	Por unidad	Por unidad	Por unidad		
13 + 90	14 GND + 125	17 + 0	16 ND + 0		
	GMT + 185	PATIN MT	NDP4 + 33		



MONACO PMT

Color / Colour / Couleur / Cor:
NEGRO EPOXI

Tela / Fabric / Tissu / Tecido:
FUGI 01 - TRASERA ROXY 03 - S/B - C FROCA

MONACO ND

Color / Colour / Couleur / Cor:
ROBLE 680 J.C.

Tela / Fabric / Tissu / Tecido:
FUGI 01 - TRASERA ROXY 03 - S/B - C FROCA

DALIA



DALIA ND

La comodidad, la funcionalidad y el diseño se personalizan en Dalia. Sigue la vanguardia estética con este modelo que no te dejará indiferente.

Comfort, functionality and design are personalized at Dalia. Follow the aesthetic avant-garde with this model that will not leave you indifferent.



DALIA PMT

Le confort, la fonctionnalité et le design sont personnalisés chez Dalia. Suivez l'esthétique avant-gardiste avec ce modèle qui ne vous laissera pas indifférent.

Conforto, funcionalidade e design são personalizados na Dalia. Siga a vanguarda estética com este modelo que não o deixará indiferente.



DALIA ND - PATA Nº4 REDONDA
Color / Colour / Couleur / Cor:
ROBLE 680 J.C.
Tela / Fabric / Tissu / Tecido:
APOLO 61 - S/B C&D

PRAGA COMEDOR - 110 Ø - 1 EXT 60 CM
Mesa / Table / Table / Mesa
Color / Colour / Couleur / Cor:
BLANCO 316 MATE J.C.
PATAS ROBLE 680 J.C.

DALIA ND
DALIA PMT

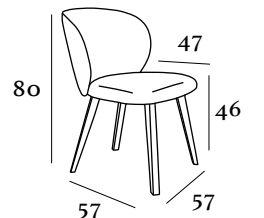
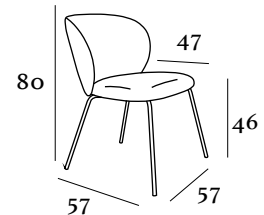





Acabados patas metal
Metal legs finishes













Barnizado, lacado
o color muestra

Varnished, lacquered or sample colour
Vernissage laqué ou couleur de l'échantillon.
Envernizamento, lacagem ou cor da amostra

	TC	SA	SB	SC	SD
	342	362	382	402	422

	 x1 unid.	 x1 unid.	 x2 unids.	 x2 unids
ND	1,25 m.	10,00 kg.	22,5 kg.	0,44 m ³
PMT	1,25 m.	9,00 kg.	20,5 kg.	0,44 m ³

OPCIONES (en puntos) / OPTIONS (points) / OPTIONS (points) / OPÇÕES (pontos)

 + 0	 + 10	 + 25	 + 10	 + 30	 + 25
	Por unidad	Por unidad	Por unidad		
 + 90	 GND + 125	 + 0	 ND + 0	 NDP4 + 33	
	GMT + 185	PATIN MT			



DALIA PMT

Color / Colour / Couleur / Cor:
NEGRO EPOXI
Tela / Fabric / Tissu / Tecido:
APOLO 61 - S/B C&D

DALIA ND

Color / Colour / Couleur / Cor:
ROBLE 680 J.C.
Tela / Fabric / Tissu / Tecido:
APOLO 61 - S/B C&D

DAKOTA



DAKOTA ND

Dakota aporta originalidad gracias a sus líneas curvas y la sutil apertura del respaldo. Unido a su potencial comodidad y ergonomía la hacen indispensable en cualquier ambiente.

Dakota brings originality thanks to its curved lines and the subtle opening of the backrest. Together with its potential comfort and ergonomics, it is indispensable in any environment.



DAKOTA MT

Dakota apporte de l'originalité grâce à ses lignes courbes et à l'ouverture subtile du dossier. Avec son potentiel de confort et d'ergonomie, il est indispensable dans n'importe quel environnement.

Dakota traz originalidade graças às suas linhas curvas e à abertura sutil do encosto. Junto com seu potencial de conforto e ergonomia, é indispensável em qualquer ambiente.



DAKOTA ND
DAKOTA MT

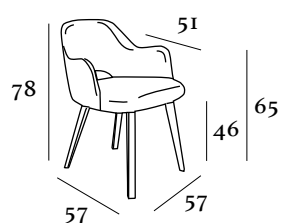
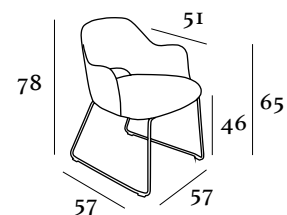

Acabados patas metal
Metal legs finishes



Barnizado, lacado
o color muestra

Varnised, lacquered or sample colour
Vernissage laqué ou couleur de l'échantillon.
Envernizamento, lacagem ou cor da amostra

TC	SA	SB	SC	SD
322	342	362	382	402

	x1 unid.	x1 unid.	x2 unids.	x2 unids.
ND	1,70 m.	9,45 kg.	21,4 kg.	0,54 m ³
MT	1,70 m.	10,45 kg.	23,4 kg.	0,54 m ³



OPCIONES (en puntos) / OPTIONS (points) / OPTIONS (points) / OPÇÕES (pontos)

3	+ 0	5	+ 10	6	+ 25	7	+ 10	9	+ 30	10	+ 25
		Por unidad		Por unidad		Por unidad					
13	+ 90	14	GND + 125	15	+ 0	16	ND + 0				
		GMT + 185		PMT		NDP4 + 33					

NEGRO EPOXI
Tela / Fabric / Tissu / Tecido:
ROCA 77 - ASIENTO CUMBRE 79 - S/B C&D



SINTRA



SINTRA SILLA

El futuro está aquí, Sintra aprovecha a la perfección sus medidas para dotarla de amplitud y comodidad en su sentada. La variedad de opciones la convierten en un modelo muy completo.

Es el concepto con el cual intentamos sintetizar la filosofía de nuestra empresa para la creación de sillas personalizadas. Equilibrio entre imaginación y razón.



SINTRA SILLÓN

Es el concepto con el cual intentamos sintetizar la filosofía de nuestra empresa para la creación de sillas personalizadas. Equilibrio entre imaginación y razón.

Es el concepto con el cual intentamos sintetizar la filosofía de nuestra empresa para la creación de sillas personalizadas. Equilibrio entre imaginación y razón.



SINTRA SILLÓN

Color / Colour / Couleur / Cor:

NEGRO EPOXI

Tela / Fabric / Tissu / Tecido:

OASIS 15 AZUL, 10 MOSTAZA, 14 ROSA PALO - S/B FROCA

MOSCÚ COMEDOR - 160 X 90 - 2 EXT 40 CM

Mesa / Table / Table / Mesa

Color / Colour / Couleur / Cor:

ROBLE 68o J.C.

SINTRA SILLA
SINTRA SILLÓN

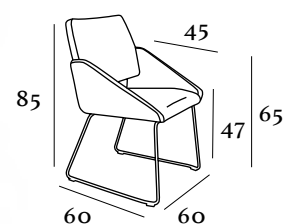
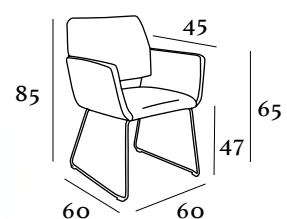

Acabados patas metal
Metal legs finishes



TC	SA	SB	SC	SD
323	353	373	393	413

	x1 unid.	x 1 unid.	x 2 unids.	x 2 unids
SILLA	1,60 m.	11,20 kg.	24,9 kg.	0,44 m ³
SILLÓN	1,80 m.	11,50 kg.	25,5 kg.	0,54 m ³



OPCIONES (en puntos) / OPTIONS (points) / OPTIONS (points) / OPÇÕES (pontos)

3 + 0	5 + 10	6 + 25	7 + 10	9 + 30	10 + 25
	Por unidad	Por unidad	Por unidad		
11 + 60	14 GND + 125	15 + 0	16 ND + 0		
	GMT + 185	PMT	NDP4 + 33		

SINTRA SILLA

Color / Colour / Couleur / Cor:
NEGRO EPOXI
Tela / Fabric / Tissu / Tecido:
THALYS 10 - S/B FROCA

SINTRA SILLÓN

Color / Colour / Couleur / Cor:
NEGRO EPOXI
Tela / Fabric / Tissu / Tecido:
OASIS 10 - S/B FROCA

LARA



LARA ND

Con Lara crear hogar es sencillo su diseño actual y sus diferentes opciones te harán disfrutar de él. Cuando el confort se alía con el diseño, la solución es el descanso.

With Lara, creating a home is simple, its current design and its different options will make you enjoy it. When comfort meets design, the solution is rest.



LARA

Avec Lara, créer une maison est simple, son design actuel et ses différentes options vous en feront profiter. Lorsque le confort rencontre le design, la solution est le repos.

Com Lara, criar uma casa é simples, seu design atual e suas diferentes opções farão você se divertir. Quando o conforto encontra o design, a solução é o descanso.



LARA MT



LARA ND - PATA Nº 4 REDONDA
Color / Colour / Couleur / Cor:
ROBLE 680 J.C.
Tela / Fabric / Tissu / Tecido:
LIDO 04 - VIVO LIDO 08 - S/B FROCA

BERLÍN COMEDOR - 160X90 - 1 Ext 60 CM
PATA 12X7 CM
Color / Colour / Couleur / Cor:
ROBLE SALVAJE J.C.

LARA
LARA MT

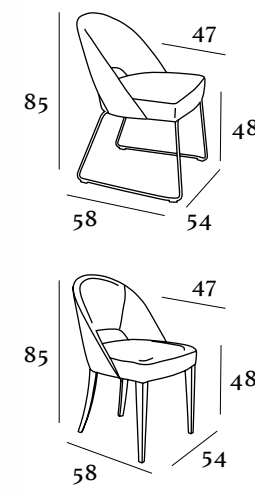

Acabados patas metal
Metal legs finishes

Barnizado, lacado o color muestra
Varnished, lacquered or sample colour
Vernissage laqué ou couleur de l'échantillon.
Envernizamento, lacagem ou cor da amostra

TC	SA	SB	SC	SD
296	316	336	356	376

LARA	x1 unid.	1,50 m.	7,7 kg.	17,9 kg.	0,43 m ³
LARA MT	x1 unid.	1,50 m.	10,2 kg.	22,9 kg.	0,43 m ³

OPCIONES (en puntos) / OPTIONS (points) / OPTIONS (points) / OPÇÕES (pontos)

1 + 33 Pata: 4 |
 3 + 0 |
 9 + 30 |
 13 + 90 |
 14 GND + 125
GMT + 185

15 + 0
PMT



LARA MT
Color / Colour / Couleur / Cor:
NEGRO EPOXI
Tela / Fabric / Tissu / Tecido:
MADONE CRUDO
RESPALDO Y TRASERA MOSCU 01 - S/B C&O - FROCA

LARA ND

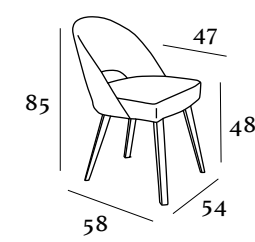

LARA ND
Color / Colour / Couleur / Cor:
ROBLE 680 J.C.
Tela / Fabric / Tissu / Tecido:
MADONE CRUDO
RESPALDO Y TRASERA MOSCU 01 - S/B C&O - FROCA

Barnizado, lacado o color muestra
Varnished, lacquered or sample colour
Vernissage laqué ou couleur de l'échantillon.
Envernizamento, lacagem ou cor da amostra

TC	SA	SB	SC	SD
296	316	336	356	376

LARA ND	x1 unid.	1,50 m.	9,7 kg.	21,9 kg.	0,43 m ³
---------	----------	---------	---------	----------	---------------------

OPCIONES (en puntos) / OPTIONS (points) / OPTIONS (points) / OPÇÕES (pontos)

3 + 0 |
 9 + 30 |
 13 + 90 |
 14 GND + 125
GMT + 185 |
 16 ND + 0
NDP4 + 33

15 + 0
PMT



LARA ND - PATA Nº 4 REDONDA
Color / Colour / Couleur / Cor:
ROBLE 680 J.C.
Tela / Fabric / Tissu / Tecido:
LIDO 04 - VIVO LIDO 08 - S/B FROCA

CONDOR



CONDOR

Sillón Córdor es una pieza enfocada a la geriatría y al hogar para cubrir cualquier necesidad. Sus líneas clásicas le aportan sencillez sin desmejorar la comodidad.

Condor armchair is a piece focused on geriatrics and the home to cover any need. Its classic lines provide simplicity without compromising comfort.

Le fauteuil Condor est une pièce axée sur la gériatrie et la maison pour couvrir tous les besoins. Ses lignes classiques offrent simplicité sans compromis sur le confort.

A poltrona Condor é uma peça voltada para a geriatría e o lar para cobrir qualquer necessidade. Suas linhas clássicas proporcionam simplicidade sem comprometer o conforto.



CONDOR
Color / Colour / Couleur / Cor:
ROBLE 315 J.C.
Tela / Fabric / Tissu / Tecido:
GRETA 16 AZAFATA - S/B - C&O

CONDOR

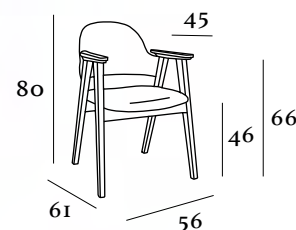

Barnizado, lacado o color muestra
 Varnished, lacquered or sample colour
 Vernissage laqué ou couleur de l'échantillon.
 Envernizamento, lacagem ou cor da amostra

TC	SA	SB	SC	SD
376	395	415	435	455

x1 sillás 1,20 m.	x1 silla 6,20 kg.	x2 sillás 14,9 kg.	x2 sillás 0,54 m ³
----------------------	----------------------	-----------------------	----------------------------------

CONDOR
 Color / Colour / Couleur / Cor:
ROBLE 315 J.C.
 Tela / Fabric / Tissu / Tecido:
GRETA 16 AZAFATA - S/B - C&O

OPCIONES (en puntos) / OPTIONS (points) / OPTIONS (points) / OPÇÕES (pontos)

- 3 + 0 |
 5 + 10 |
 6 + 25 |
 7 + 10 |
 9 + 30 |
 11 + 60 |
 13 + 90
 Por unidad | Por unidad | Por unidad | Por unidad | Por unidad | Por unidad | Por unidad



DENVER
LONDRES
PRESTON



DÉNVER

Dénver, Londres y Preston son una familia contemporánea, que nunca pasa de moda combinando toques clásicos y actuales que se han convertido en un ícono de referencia para otros modelos.

Denver, London and Preston are a contemporary family, which never goes out of style, combining classic and current touches that have become a reference icon for other models.



LONDRES

Denver, London et Preston forment une famille contemporaine, qui ne se démode jamais, alliant des touches classiques et actuelles qui sont devenues une icône de référence pour d'autres modèles.

Denver, Londres e Preston são uma família contemporânea, que nunca sai de moda, combinando toques clássicos e atuais que se tornaram um ícone de referência para outros modelos.



PRESTON

PRESTON
Color / Colour / Couleur / Cor:
ROBLE 315 J.C.
Tela / Fabric / Tissu / Tecido:
LENNON GRIS 09 - LATERALES LUCCA 07 - S/B C&O - BITEX

DÉNVER

LONDRES

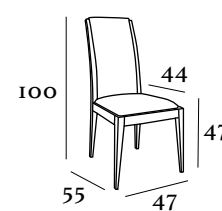

Barnizado, lacado o color muestra
 Varnished, lacquered or sample colour
 Vernissage laqué ou couleur de l'échantillon.
 Envernizamento, lacagem ou cor da amostra

TC	SA	SB	SC	SD
280	300	320	340	360

x1 sillas	capitoné x1 sillas	x1 silla	x2 sillas	x2 sillas
1,6 m.	2,00 m.	6,70 kg.	15,8 kg.	0,44 m ³

OPCIONES (en puntos) / OPTIONS (points) / OPTIONS (points) / OPÇÕES (pontos)

1 + 0	2 + 95	3 + 0	5 + 10	6 + 25
Patas: 2,3,5	Brazo: 1-2-3	Por unidad	Por unidad	Por unidad
7 + 10	8 + 25	11 + 60	12 + 140	13 + 90
Por unidad				

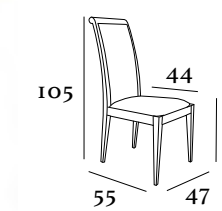

Barnizado, lacado o color muestra
 Varnished, lacquered or sample colour
 Vernissage laqué ou couleur de l'échantillon.
 Envernizamento, lacagem ou cor da amostra

TC	SA	SB	SC	SD
280	300	320	340	360

x1 sillas	capitoné x1 sillas	x1 silla	x2 sillas	x2 sillas
1,6 m.	2,00 m.	7,00 kg.	16,5 kg.	0,44 m ³

OPCIONES (en puntos) / OPTIONS (points) / OPTIONS (points) / OPÇÕES (pontos)

1 + 0	2 + 95	3 + 0	5 + 10	6 + 25
Patas: 2,3,5	Brazo: 1-2-3	Por unidad	Por unidad	Por unidad
7 + 10	8 + 25	11 + 60	12 + 140	13 + 90
Por unidad				

LONDRES
 Color / Colour / Couleur / Cor:
NEGRO 318 MATE J.C.
 Tela / Fabric / Tissu / Tecido:
ATENA 55 - S/B C&D

PRESTON

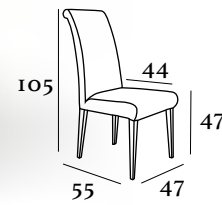

Barnizado, lacado o color muestra

Varnished, lacquered or sample colour
Vernissage laqué ou couleur de l'échantillon.
Envernizamento, lacagem ou cor da amostra

TC SA SB SC SD

280 300 320 340 360

x1 sillas 1,6 m. x1 silla 3,00 m. x1 silla 7,00 kg. x2 sillas 16,5 kg. x2 sillas 0,44 m³

PRESTON
Color / Colour / Couleur / Cor:
BLANCO 316 MATE J.C.
Tela / Fabric / Tissu / Tecido:
LENNON GRIS 09
LATERALES LUCCA 04 - S/B C&D - BITEX

OPCIONES (en puntos) / **OPTIONS** (points) / **OPTIONS** (points) / **OPÇÕES** (pontos)

- 1 + 0 Patas: 2,3,5
+ 33 Pata: 4
- 2 + 95 Brazo: 1-2-3
- 3 + 0
- 5 + 10 Por unidad
- 6 + 25 Por unidad
- 7 + 10 Por unidad
- 11 + 60
- 12 + 240
- 13 + 90



BOSTON



BOSTON

Amplitud y sencillo diseño son caracteres perfectamente combinados por Boston, dando importancia a la madera ese material noble y agradable que tanto nos aporta.

Amplitude and simple design are characters perfectly combined by Boston, giving importance to wood that noble and pleasant material that gives us so much.

L'amplitude et le design simple sont des caractères parfaitement combinés par Boston, donnant de l'importance au bois, ce matériau noble et agréable qui nous donne tant.

Amplitude e design simples são personagens perfeitamente combinados por Boston, dando importância à madeira naquele material nobre e agradável que tanto nos dá.



BOSTON
Color / Colour / Couleur / Cor:
ROBLE 68o MATE J.C.
Tela / Fabric / Tissu / Tecido:
CIMA 61 - S/B C&D

TEMPO COMEDOR - CHAPA ROBLE SALVAJE NATURAL
Mesa / Table / Table / Mesa:
Color / Colour / Couleur / Cor:
ROBLE SALVAJE J.C.
PATAS NEGRO MATE 318 J.C.

BOSTON

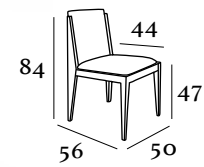

Barnizado, lacado o color muestra
 Varnished, lacquered or sample colour
 Vernissage laqué ou couleur de l'échantillon.
 Envernizamento, lacagem ou cor da amostra

TC	SA	SB	SC	SD
283	303	323	343	363

x1 sillas 1,25 m.	x1 silla 6,20 kg.	x2 sillas 14,8 kg.	x2 sillas 0,43 m ³
----------------------	----------------------	-----------------------	----------------------------------

OPCIONES (en puntos) / OPTIONS (points) / OPTIONS (points) / OPÇÕES (pontos)

- 1 + 0
Patas: 2-3-5
- 2 + 95
Brazo: 1-2-3
- 3 + 0
- 5 + 10
Por unidad
- 6 + 25
Por unidad
- 7 + 10
Por unidad
- 8 + 25
- 10 + 25
- 13 + 90

BOSTON
 Color / Colour / Couleur / Cor:
ROBLE 68o MATE J.C.
 Tela / Fabric / Tissu / Tecido:
CIMA 6r - S/B C&D

IBIZA
TOKIO



IBIZA

Ibiza y Tokio, son dos referentes para la empresa J. Calvo. Su atrayente precio unido a la calidad base de sus materiales las hacen dos grandes de la familia.

Ibiza and Tokyo are two benchmarks for the J. Calvo company. Their attractive price together with the basic quality of their materials make them two of the greats of the family.



TOKIO P2

Ibiza et Tokyo sont deux références pour la société J. Calvo. Leur prix attractif ainsi que la qualité basique de leurs matériaux en font deux des grands de la famille.

Ibiza e Tóquio são duas referências para a empresa J. Calvo. O seu preço atractivo aliado à qualidade básica dos seus materiais fazem deles dois dos grandes da família.



IBIZA
Color / Colour / Couleur / Cor:
VULCANO TEX J.C.
Tela / Fabric / Tissu / Tecido:
ZOE 14 - S/B FROCA

IBIZA

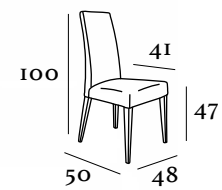

Barnizado, lacado o color muestra

Varnished, lacquered or sample colour
Vernissage laqué ou couleur de l'échantillon.
Envernizamento, lacagem ou cor da amostra

TC	SA	SB	SC	SD
215	235	258	278	298

x1 sillas 1,5 m.	capitón x1 sillas 2,00 m.	x1 silla 6,40 kg.	x2 sillas 15,2 kg.	x2 sillas 0,43 m ³
---------------------	------------------------------	----------------------	-----------------------	----------------------------------

OPCIONES (en puntos) / OPTIONS (points) / OPTIONS (points) / OPÇÕES (pontos)

1 + 0 Patatas: 2,3,5 + 33 Pata: 4	2 + 95 Brazo: 1-2-3	3 + 0	4 + 65	5 + 10 Por unidad	6 + 25 Por unidad
7 + 10 Por unidad	9 + 30	10 + 25	12 + 240	13 + 90	



TOKIO P2

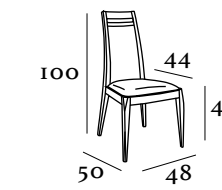

Barnizado, lacado o color muestra

Varnished, lacquered or sample colour
Vernissage laqué ou couleur de l'échantillon.
Envernizamento, lacagem ou cor da amostra

TC	SA	SB	SC	SD
215	235	258	278	298

x1 sillas 1,2 m.	x1 silla 6,00 kg.	x2 sillas 14,5 kg.	x2 sillas 0,43 m ³
---------------------	----------------------	-----------------------	----------------------------------

OPCIONES (en puntos) / OPTIONS (points) / OPTIONS (points) / OPÇÕES (pontos)

1 + 0 Patatas: 1-3-5	2 + 95 Brazo: 1-2-3	3 + 0	5 + 10 Por unidad	6 + 25 Por unidad	7 + 10 Por unidad
8 + 25	10 + 25				



TOKIO P2
Color / Colour / Couleur / Cor:
BLANCO 316 MATE J.C.
Tela / Fabric / Tissu / Tecido:
ZEUS 07 - S/B FROCA

DALLAS



DALLAS

Cuando rescatas un clásico y logras aligerar sus líneas, consigues crear un icono de comodidad, confort y porqué no decirlo, de neoclasicismo. actualizado.

When you rescue a classic and manage to lighten its lines, you manage to create an icon of comfort, comfort and why not say it, of neoclassicism. updated.

Lorsque vous sauvez un classique et parvenez à alléger ses lignes, vous parvenez à créer une icône de confort, de confort et pourquoi pas, de néoclassicisme. mis à jour.

Quando você resgata um clássico e consegue iluminar suas linhas, você consegue criar um ícone de conforto, conforto e porque não dizer, do neoclasicismo. Atualizada.



DALLAS

Color / Colour / Couleur / Cor:
NEGRO 318 MATE J.C.
Tela / Fabric / Tissu / Tecido:
ZEUS 04 - S/B FROCA

DALLAS

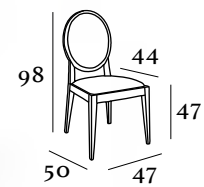

Barnizado, lacado
o color muestra

Varnised, lacquered or sample colour
Vermissage laqué ou couleur de l'échantillon.
Envernizamento, lacagem ou cor da amostra

TC	SA	SB	SC	SD
326	346	366	386	406

x1 sillas	capitoné x1 sillas	x 1 silla	x 2 sillas	x 2 sillas
0,8 m.	1,30 m.	7,00 kg.	16,2 kg.	0,43 m ³

OPCIONES (en puntos) / OPTIONS (points) / OPTIONS (points) / OPÇÕES (pontos)

1 + 0	2 + 95	3 + 0	4 + 65	5 + 10	6 + 25
Patás: 2-3-5		Brazo: 1-2		Por unidad	Por unidad
7 + 10	8 + 25	10 + 25	12 + 140	13 + 90	
Por unidad					

DALLAS
Color / Colour / Couleur / Cor:
NEGRO 318 MATE J.C.
Tela / Fabric / Tissu / Tecido:
ZEUS 04 - S/B FROCA

ISABELLA



ISABELLA

Con un encanto que perdurará en el tiempo, un clásico adaptado a día de hoy, tu hogar tendrá una elegancia difícil de superar. Confortable, divertida, elegante.

With a charm that will last over time, a classic adapted to today, your home will have an elegance that is hard to beat. Comfortable, fun, elegant.

Avec un charme qui durera dans le temps, un classique adapté à aujourd'hui, votre maison aura une élégance difficile à battre. Confortable, amusant, élégant.

Com um encanto que vai durar no tempo, um clássico adaptado aos dias de hoje, a sua casa terá uma elegância inigualável. Confortável, divertido e elegante.



ISABELLA

Color / Colour / Couleur / Cor:

BLANCO 316 MATE J.C.

Tela / Fabric / Tissu / Tecido:

VALLE 65 TRASERA CUMBRE 60 - S/B C&D

ISABELLA

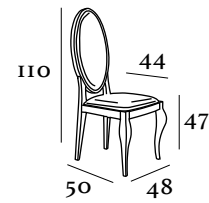

Barnizado, lacado
o color muestra

Varnished, lacquered or sample colour
Vernissage laqué ou couleur de l'échantillon.
Envernizamento, lacagem ou cor da amostra

TC	SA	SB	SC	SD
342	362	382	402	422

 x1 sillas 1,0 m.	 capitoné x1 sillas 1,50 m.	 x1 silla 7,00 kg.	 x2 sillas 16,2 kg.	 x2 sillas 0,43 m ³
---	---	---	---	--

OPCIONES (en puntos) / OPTIONS (points) / OPTIONS (points) / OPÇÕES (pontos)

1 + 0 Patas: 1-2-3	2 + 95 Brazo: 1-2	3 + 0	4 + 65	5 + 10 Por unidad	6 + 25 Por unidad
7 + 10 Por unidad	8 + 25	10 + 25	12 + 140	13 + 90	

ISABELLA
Color / Colour / Couleur / Cor:
BLANCO 316 MATE J.C.
Tela / Fabric / Tissu / Tecido:
VALLE 65 TRASERA CUMBRE 60 - S/B C&D



KARLA
BELLA



KARLA

O bien en madera o bien tapizada esta pequeña familia te permite crear decoración y dotar de personalidad a tu hogar otra característica a tener en cuenta cuando se trata de tu entorno.

Either in wood or upholstered, this small family allows you to create decoration and give your home personality another characteristic to take into account when it comes to your environment.



BELLA 95

Qu'elle soit en bois ou tapissée, cette petite famille vous permet de créer une décoration et de donner à votre maison une personnalité supplémentaire à prendre en compte lorsqu'il s'agit de votre environnement.

Seja em madeira ou estofada, esta pequena família permite-lhe criar uma decoração e dar à sua casa a personalidade mais uma característica a ter em conta no que diz respeito ao seu ambiente.



BELLA 105

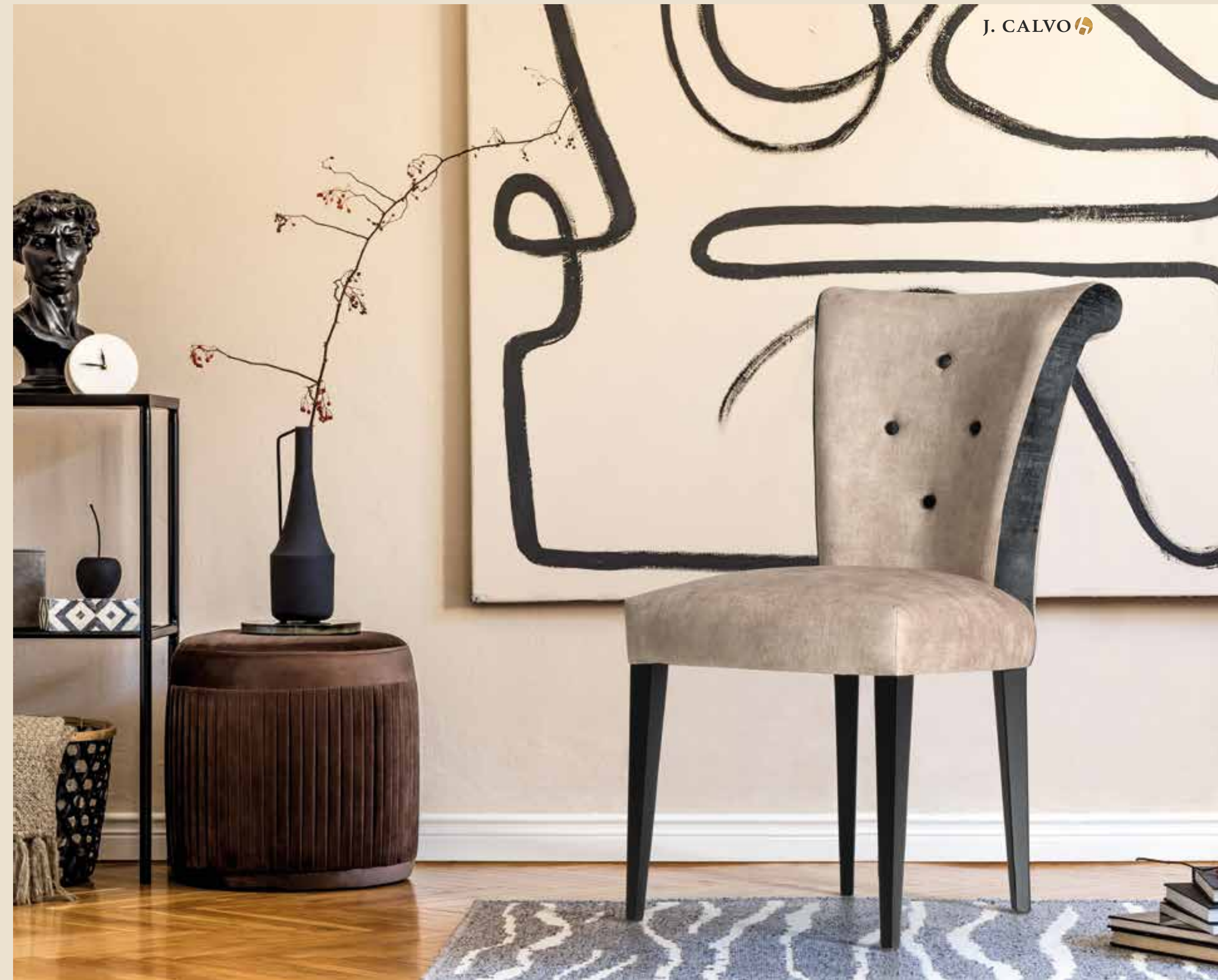

BELLA 95

Color / Colour / Couleur / Cor:
NEGRO 318 MATE J.C.
Tela / Fabric / Tissu / Tecido:
NAGORE 06, BOTÓN Y LATERALES
NAGORE 01 - S/B FROCA

KARLA

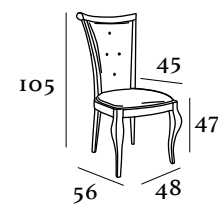

Barnizado, lacado
o color muestra

Varnished, lacquered or sample colour
Vernissage laqué ou couleur de l'échantillon.
Envernizamento, lacagem ou cor da amostra

TC	SA	SB	SC	SD
376	396	416	436	456

 x1 sillas	 capitoné x 1 sillas	 x 1 silla	 x 2 sillas	 x 2 sillas
1,50 m.	2,00 m.	7,60 kg.	17,5 kg.	0,44 m ³

OPCIONES (en puntos) / OPTIONS (points) / OPTIONS (points) / OPÇÕES (pontos)

1 + 0	2 + 95	3 + 0	5 - 10	6 + 25	7 + 10
Patas: 1-2-3	Brazo: 1-2		Por unidad	Por unidad	Por unidad
8 + 25	10 + 25	11 + 60	12 + 240	13 + 90	

KARLA

Color / Colour / Couleur / Cor:
BLANCO 316 MATE J.C.
Tela / Fabric / Tissu / Tecido:
SIERRA 30 - C&D

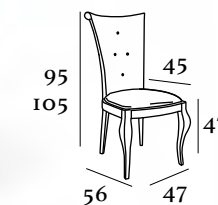
BELLA 95
BELLA 105

Barnizado, lacado
o color muestra

Varnished, lacquered or sample colour
Vernissage laqué ou couleur de l'échantillon.
Envernizamento, lacagem ou cor da amostra

TC	SA	SB	SC	SD
376	396	416	436	456

 x1 sillas	 capitoné x 1 sillas	 x 1 silla	 x 2 sillas	 x 2 sillas
1,70 m.	2,20 m.	7,50 kg.	17,5 kg.	0,44 m ³

OPCIONES (en puntos) / OPTIONS (points) / OPTIONS (points) / OPÇÕES (pontos)

1 + 0	2 + 95	3 + 0	5 - 10	6 + 25	7 + 10
Patas: 1,2,3	Brazo: 1-2-7-8		Por unidad	Por unidad	Por unidad
9 + 30	10 + 25	11 + 60	12 + 240	13 + 90	



BELLA 105

Color / Colour / Couleur / Cor:
NEGRO 318 MATE J.C.
Tela / Fabric / Tissu / Tecido:
NAGORE 06 - BOTÓN Y LATERALES
NAGORE 01 - S/B FROCA

MILAN



MILÁN

Las orejeras de su respaldo la convierten en una original forma de confort que permiten, todavía más, si cabe, encontrar en una misma silla con un diseño sobrio.

The ear flaps on its back make it an original form of comfort that allows, even more, if possible, to be found in the same chair with a sober design.

Les oreillettes sur son dossier en font une forme de confort originale qui permet, encore plus, si possible, de se retrouver dans une même chaise au design sobre.

As abas auriculares nas suas costas conferem-lhe uma forma original de conforto que permite, ainda mais, se possível, estar na mesma cadeira com um design sóbrio.



MILÁN

Color / Colour / Couleur / Cor:

VULCANO TEX J.C.

Tela / Fabric / Tissu / Tecido:

SOL 01 - TRASERA Y OREJAS BIL 1 - S/B BITEK

MILAN

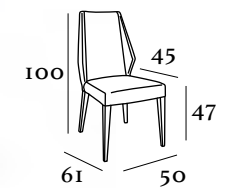

Barnizado, lacado
o color muestra
*Varnished, lacquered or sample colour
Vernissage laqué ou couleur de l'échantillon.
Envernizamento, lacagem ou cor da amostra*

	TC	SA	SB	SC	SD
	273	293	313	333	353
	x1 sillas	x1 silla	x2 sillas	x2 sillas	
	1,60 m.	7,00 kg.	16,5 kg.	0,43 m ³	

OPCIONES (en puntos) / OPTIONS (points) / OPTIONS (points) / OPÇÕES (pontos)

- 1 + 0 Patas: 2,3,5
- 3 + 0
- 4 + 65
- 5 + 10
- 6 + 25
- + 33 Patata: 4
- Por unidad
- Por unidad
- 7 + 10
- 10 + 25
- 11 + 60
- 13 + 90
- Por unidad

MILÁN
Color / Colour / Couleur / Cor:
VULCANO TEX J.C.
Tela / Fabric / Tissu / Tecido:
SOL 01 - TRASERA Y OREJAS BIL 1 - S/B BITEX

OSLO



OSLO ND 90-105

Oslo y su vivo contrastado consigue alcanzar el punto de decoración y combinación idóneos para tu salón. Perfecta para espacios públicos o privados, históricos o contemporáneos.

Oslo and its contrasting vividness manages to reach the ideal decoration and combination point for your living room. Perfect for public or private, historical or contemporary spaces.



OSLO 90-105

Oslo et sa vivacité contrastée parvient à atteindre le point de décoration et de combinaison idéal pour votre salon. Idéal pour les espaces publics ou privés, historiques ou contemporains.

Oslo e sua vivacidade contrastante conseguem alcançar a decoração e o ponto de combinação ideais para sua sala de estar. Perfeito para espaços públicos ou privados, históricos ou contemporâneos.



OSLO MT 90-105



OSLO ND 90
Color / Colour / Couleur / Cor:
ROBLE 680 J.C.
Tela / Fabric / Tissu / Tecido:
BRUNEI 38 - VIVO BRUNEI 6 - S/B FROCA

MANHATTAN COMEDOR
Mesa / table / Table / Mesa:
Color / Colour / Couleur / Cor:
ARENA 853 MATE J.C.
BASE METAL NEGRO EPOXI

OSLO 90 - 105
OSLO ND 90 - 105

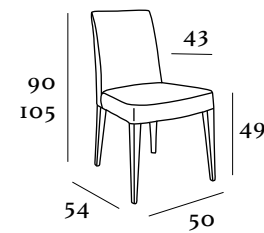

Barnizado, lacado o color muestra

Varnished, lacquered or sample colour
Vernissage laqué ou couleur de l'échantillon.
Envernizamento, lacagem ou cor da amostra

TC	SA	SB	SC	SD
273	293	313	333	353

OSLO	x1 unid. 1,40 m.	x1 unid. 6,0 kg.	x2 unids. 15,0 kg.	x2 unids. 0,43 m ³
OSLO ND	1,40 m.	6,8 kg.	16,1 kg.	0,43 m ³

OPCIONES (en puntos) / OPTIONS (points) / OPTIONS (points) / OPÇÕES (pontos)

1 + 0	Patas: 2,3,5	2 + 95	3 + 0	4 + 65	5 + 10	6 + 25
+ 33	Patata: 4	Brazo: 1,2,3		Por unidad	Por unidad	Por unidad
7 + 10	9 - 30	10 + 25	11 + 60	13 + 90	14 GND + 125	
Por unidad					GMT + 185	
15 + 0	PMT	16 ND + 0				
		NDP ₄ + 33				

OSLO 90

Color / Colour / Couleur / Cor:

ROBLE 315 J.C.

Tela / Fabric / Tissu / Tecido:

ELIOS 61 - VIVO MADONE CRUDO - S/B C&D - C&O

OSLO MT 90 - 105



OSLO 90 ND

Color / Colour / Couleur / Cor:

ROBLE 680 J.C.

Tela / Fabric / Tissu / Tecido:

CHARLOTTE 33 - VIVO DOLCE o8 - S/B C&D - FROCA

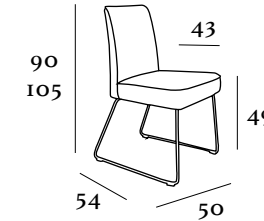

Acabados patas metal

Metal legs finishes
Negro epoxi Blanco epoxi Cromo Oro epoxi

TC	SA	SB	SC	SD
273	293	313	333	353

OSLO MT	x1 unid. 1,40 m.	x1 unid. 8,7 kg.	x2 unids. 19,9 kg.	x2 unids. 0,43 m ³
---------	---------------------	---------------------	-----------------------	----------------------------------

OPCIONES (en puntos) / OPTIONS (points) / OPTIONS (points) / OPÇÕES (pontos)

2 + 95	3 + 0	4 + 65	5 + 10	6 + 25	7 + 10	9 - 30
Brazo: 1,2,3		Por unidad	Por unidad	Por unidad	Por unidad	
10 + 25	11 + 60	13 + 90	14 GND + 125			
			GMT + 185	15 + 0	PMT	

OSLO 90 MT

Color / Colour / Couleur / Cor:

NEGRO EPOXI

Tela / Fabric / Tissu / Tecido:

CHARLOTTE 33 - VIVO DOLCE o8 - S/B C&D - FROCA

CATANIA
TREVI



CATANIA

Catania y Trevi, dos sillas que te seducen al sentarte, la confortabilidad sobre todo es su punto fuerte, pero no deja al lado su sello elegante con una estructura robusta en madera.

Catania and Trevi, two chairs that seduce you when you sit down, comfort is above all its strong point, but it does not neglect its elegant stamp with a robust wooden structure.



TREVI

Catania et Trevi, deux chaises qui vous séduisent lorsque vous vous asseyez, le confort est avant tout son point fort, mais elle ne néglige pas pour autant son cachet élégant avec une structure en bois robuste.

Catânia e Trevi, duas cadeiras que o seduzem ao sentar, o conforto é acima de tudo o seu ponto forte, mas não descarta a sua estampa elegante com uma estrutura de madeira robusta.



CATANIA

Color / Colour / Couleur / Cor:

ROBLE 315 J.C.

Tela / Fabric / Tissu / Tecido:

GRETA 16 AZAFATA - ASIENTO ANSEL MARINO - S/B C&O

AREN COMEDOR - CHAPA HAYA NATURAL

Mesa / Table / Table / Mesa

Color / Colour / Couleur / Cor:

ROBLE 315 J.C.

CATANIA

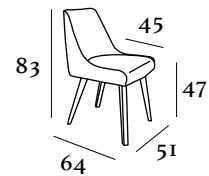

Barnizado, lacado o color muestra
 Varnished, lacquered or sample colour
 Vernissage laqué ou couleur de l'échantillon.
 Envernizamento, lacagem ou cor da amostra

TC	SA	SB	SC	SD
273	293	313	333	353

x1 sillas	x1 silla	x2 sillas	x2 sillas
1,40 m.	6,80 kg.	16,1 kg.	0,43 m ³

OPCIONES (en puntos) / OPTIONS (points) / OPTIONS (points) / OPÇÕES (pontos)

3 + 0 | 5 + 10 | 6 + 25 | 7 + 10 | 9 + 30 | 10 + 25 | 11 + 60
 Por unidad | Por unidad | Por unidad

14 GND + 125 | 15 + 0 | 17 + 0 | 16 ND + 0
 GMT + 185 | PMT | PMT | NDP4 + 33

CATANIA
 Color / Colour / Couleur / Cor:
VULCANO TEX J.C.
 Tela / Fabric / Tissu / Tecido:
MYSTIC 503 - S/C AQUA CLEAN

TREVI

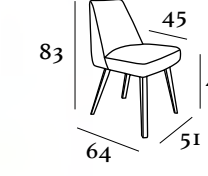

Barnizado, lacado o color muestra
 Varnished, lacquered or sample colour
 Vernissage laqué ou couleur de l'échantillon.
 Envernizamento, lacagem ou cor da amostra

TC	SA	SB	SC	SD
273	293	313	333	353

x1 sillas	x1 silla	x2 sillas	x2 sillas
1,40 m.	6,80 kg.	16,1 kg.	0,43 m ³

OPCIONES (en puntos) / OPTIONS (points) / OPTIONS (points) / OPÇÕES (pontos)

3 + 0 | 5 + 10 | 6 + 25 | 7 + 10 | 9 + 30 | 10 + 25 | 11 + 60
 Por unidad | Por unidad | Por unidad

14 GND + 125 | 15 + 0 | 17 + 0 | 16 ND + 0
 GMT + 185 | PMT | PMT | NDP4 + 33

TREVI
 Color / Colour / Couleur / Cor:
ROBLE 680 J.C.
 Tela / Fabric / Tissu / Tecido:
BRUNEI 34 - TRASERA BRESCIA 12 - S/B FROCA

VENECIA



VENECIA 90 FC
VENECIA 100 FC
(opción nºII -Faslo capitone)

Modelo referencia en J. Calvo, ahora es presentada en dos alturas y con diferente decoración en la tapicería, lo que la hace mas competitiva sin dejar de perder su encanto ganado a pulso.

Reference model in J. Calvo, now it is presented in two heights and with different upholstery decoration, which makes it more competitive while still losing its hard-earned charm.



VENECIA 90
VENECIA 100

Modèle de référence chez J. Calvo, il est désormais présenté en deux hauteurs et avec une décoration de sellerie différente, ce qui le rend plus compétitif tout en perdant son charme durement gagné.

Modelo de referência da J. Calvo, agora apresenta-se em duas alturas e com decoração estofada diferenciada, o que o torna mais competitivo, mas perde o seu encanto conquistado a duras penas.



VENECIA 90 FC
Color / Colour / Couleur / Cor:
BLANCO 316 MATE J.C.
Tela / Fabric / Tissu / Tecido:
ERMES 05 OCRE - S/B C&O

VENECIA 90
 VENECIA 100
 VENECIA 90FC
 VENECIA 100 FC

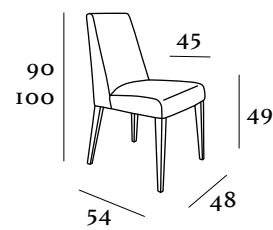

Barnizado, lacado o color muestra
 Varnished, lacquered or sample colour
 Vernissage laqué ou couleur de l'échantillon
 Envernizamento, lacagem ou cor da amostra

	TC	SA	SB	SC	SD
VENECIA	273	293	313	333	353
VENECIA FC	333	353	373	393	413

x1 sillas	x1 silla	x2 sillas	x2 sillas
1,50 m.	7,20 kg.	17,5 kg.	0,44 m ³



OPCIONES (en puntos) / OPTIONS (points) / OPTIONS (points) / OPÇÕES (pontos)

- 1 + 0 Patas: 2,3,5
- 2 + 95 Brazo: 1,2,3
- 3 + 0
- 4 + 65
- 5 + 10 Por unidad
- 6 + 25 Por unidad
- 7 + 10 Por unidad
- 9 + 30
- 10 + 25
- 11 + 60
- 13 + 90

VENECIA 100

Color / Colour / Couleur / Cor:
 ROBLE 315 J.C.
 Tela / Fabric / Tissu / Tecido:
 ERMES PLOMO - BOTONES Y LATERALES ROXY 02 - S/B C&O

VENECIA 90 FC

Color / Colour / Couleur / Cor:
 BLANCO 316 MATE J.C.
 Tela / Fabric / Tissu / Tecido:
 ERMES 05 OCRE - S/B C&O

FLORENCIA
GÉNOVA



FLORENCIA L
FLORENCIA XL

Un clásico a la vanguardia. La anchura de su respaldo unida a la posibilidad de poder elegir entre dos tallas, L o XL. La versión L tiene un respaldo mas estilizado que le confiere mas posibilidades para equipar diferentes entornos ya sea para el hogar o para contract.

A classic at the forefront. The width of its backrest together with the possibility of choosing between two sizes, L or XL. The L version has a more stylized backrest that gives it more possibilities to equip different environments either for the home or for contract.



GÉNOVA L
GÉNOVA XL

Un classique au premier plan. La largeur de son dossier ainsi que la possibilité de choisir entre deux tailles, L ou XL. La version L a un dossier plus stylisé qui lui donne plus de possibilités d'équiper différents environnements que ce soit pour la maison ou pour le contrat.

Um clássico na vanguarda. A largura do seu encosto junto com a possibilidade de escolher entre dois tamanhos, L ou XL. A versão L tem um encosto mais estilizado que lhe dá mais possibilidades de equipar diferentes ambientes para a casa como para empreitadas.



FLORENCIA XL
Color / Colour / Couleur / Cor:
ROBLE 315 J.C.
Tela / Fabric / Tissu / Tecido:
SOL 01 TRASERA NIKI 01 - S/B BITEX

FLORENCIA L
FLORENCIA XL

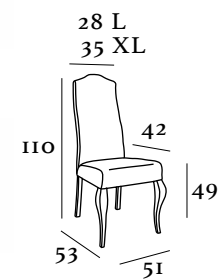

Barnizado, lacado
o color muestra
Varnished, lacquered or sample colour
Vernissage laqué ou couleur de l'échantillon.
Envernizamento, lacagem ou cor da amostra

TC	SA	SB	SC	SD
345	365	385	405	425

 x1 sillas	 capitoné x1 sillas	 x1 silla	 x2 sillas	 x2 sillas
1,70 m.	2,20 m.	7,00 kg.	16,5 kg.	0,44 m ³

OPCIONES (en puntos) / OPTIONS (points) / OPTIONS (points) / OPÇÕES (pontos)

1 + 0 Patas: 1,2,3	2 + 95 Brazo: 1,2	3 + 0	4 + 65	5 + 10 Por unidad	6 + 25 Por unidad
7 + 10 Por unidad	8 + 33 Pata: 4	9 + 30	10 + 25	11 - 60	12 + 240
13 + 90					



GÉNOVA L
GÉNOVA XL

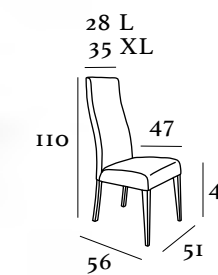

Barnizado, lacado
o color muestra
Varnished, lacquered or sample colour
Vernissage laqué ou couleur de l'échantillon.
Envernizamento, lacagem ou cor da amostra

TC	SA	SB	SC	SD
345	365	385	405	425

 x1 sillas	 capitoné x1 sillas	 x1 silla	 x2 sillas	 x2 sillas
1,75 m.	2,25 m.	7,00 kg.	16,5 kg.	0,44 m ³

OPCIONES (en puntos) / OPTIONS (points) / OPTIONS (points) / OPÇÕES (pontos)

1 + 0 Patas: 2,3,5	2 + 95 Brazo: 1,2	3 + 0	4 + 65	5 + 10 Por unidad	6 + 25 Por unidad
7 + 10 Por unidad	8 + 33 Pata: 4	9 + 30	10 + 25	11 - 60	12 + 240
13 + 90					



GÉNOVA XL
Color / Colour / Couleur / Cor:
ROBLE 680 J.C.
Tela / Fabric / Tissu / Tecido:
MADONE BLANCO ROTO - LATERALES BIL 14
S/B C&O - BITEX

CARMELA



CARMELA

Con Carmela volvemos a rescatar un clásico para adaptarlo a la máxima expresión de la sencillez al servicio de la comodidad. Un diseño permanente que seguirá seduciendo por muchos años más.

With Carmela we return to rescue a classic to adapt it to the maximum expression of simplicity at the service of comfort. A permanent design that will continue to seduce for many years to come.

Avec Carmela, nous revenons à la rescousse d'un classique pour l'adapter à l'expression maximale de la simplicité au service du confort. Un design permanent qui continuera de séduire pendant de nombreuses années.

Com a Carmela voltamos a resgatar um clássico para o adaptar à máxima expressão da simplicidade ao serviço do conforto. Um design permanente que continuará a seduzir por muitos anos.



CARMELA

Color / Colour / Couleur / Cor:
BLANCO 326 MATE J.C.
Tela / Fabric / Tissu / Tecido:
ZEUS 13 - VIVO DOLCE o8 - S/B FROCA

CARMELA

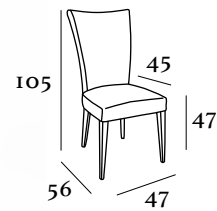

Barnizado, lacado
o color muestra

Varnished, lacquered or sample colour
Vernissage laqué ou couleur de l'échantillon.
Envernizamento, lacagem ou cor da amostra

TC	SA	SB	SC	SD
376	396	416	436	456

 x1 sillas 1,75 m.	 capitone x1 sillas 2,25 m.	 x1 silla 7,50 kg.	 x2 sillas 17,5 kg.	 x2 sillas 0,44 m ³
--	---	--	---	--

OPCIONES (en puntos) / OPTIONS (points) / OPTIONS (points) / OPÇÕES (pontos)

- 1 + 0 Patas: 2,3,5
+ 33 Pata: 4
- 2 + 95 Brazo: 1,2
- 3 + 0
- 4 + 65
- 5 + 10 Por unidad
- 6 + 25 Por unidad
- 7 + 10 Por unidad
- 9 - 30
- 10 + 25
- 11 + 60
- 12 + 240
- 13 + 90

CARMELA
Color / Colour / Couleur / Cor:
BLANCO 326 MATE J.C.
Tela / Fabric / Tissu / Tecido:
ZEUS 13 - VIVO DOLCE 08

BALI



BALI

Bali una pieza que nos vio nacer y nosotros a él, juntos seguimos sumando en muchos hogares gracias a su gran versatilidad. Una gama completa y seductora.

Bali a piece that saw us born and we him, together we continue to add in many homes thanks to its great versatility. A complete and seductive range.



BALI MT

Bali une pièce qui nous a vu naître et nous lui, ensemble, nous continuons à ajouter dans de nombreux foyers grâce à sa grande polyvalence. Une gamme complète et séduisante.

Bali uma peça que nos viu nascer e nós a ele, juntos continuamos a agregar em muitos lares graças à sua grande versatilidade. Uma gama completa e sedutora.



BALI ND



INDO - CENTRO
Color / Colour / Couleur / Cor:
TAPA BLANCO 316 MATE J.C.
PATASROBLE 680 J.C.

BALI
Color / Colour / Couleur / Cor:
ROBLE 315 J.C.
Tela / Fabric / Tissu / Tecido:
ROCA 78 - TRASERA CUMBRE 09 - S/B C&D

BALI
BALI ND

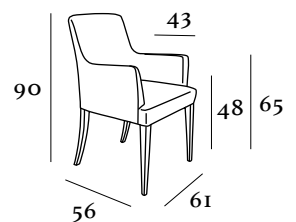

Barnizado, lacado o color muestra

Varnished, lacquered or sample colour
Vernissage laqué ou couleur de l'échantillon.
Envernizamento, lacagem ou cor da amostra

	TC	SA	SB	SC	SD
	322	342	362	382	402

	Icon	Unit	Weight	Volume
BALI	Icon	x1 unid.	1,75 m.	0,54 m ³
BALI ND	Icon	x1 unid.	8,4 kg.	
	Icon	x2 unids.	19,3 kg.	
	Icon	x2 unids.	23,1 kg.	0,54 m ³

OPCIONES (en puntos) / OPTIONS (points) / OPTIONS (points) / OPÇÕES (pontos)

1 + 0 Patas: 2,3,5	3 + 0	5 + 10	6 + 25	7 + 10	9 + 30
+ 33 Pata: 4	Por unidad	Por unidad	Por unidad	Por unidad	
11 + 60	10 + 25	13 + 90	14 GND + 125 GMT + 185	15 + 0 PMT	16 ND + 0 NDP + 33



BALI ND

Color / Colour / Couleur / Cor:
ROBLE 315 J.C.
Tela / Fabric / Tissu / Tecido:
SOL or - ASIENTO NIKI or - S/B BITEK

BALI MT

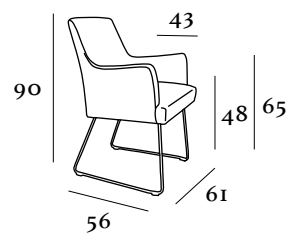

Acabados patas metal

Metal legs finishes



	TC	SA	SB	SC	SD
	322	342	362	382	402

	Icon	Unit	Weight	Volume
BALI MT	Icon	x1 unid.	1,75 m.	0,54 m ³
	Icon	x1 unid.	10,9 kg.	
	Icon	x2 unids.	24,3 kg.	
	Icon	x2 unids.		0,54 m ³

OPCIONES (en puntos) / OPTIONS (points) / OPTIONS (points) / OPÇÕES (pontos)

3 + 0	5 + 10	6 + 25	7 + 10	9 + 30	11 + 60
Por unidad	Por unidad	Por unidad	Por unidad	Por unidad	
10 + 25	13 + 90	14 GND + 125 GMT + 185	15 + 0 PMT		

BALI MT

Color / Colour / Couleur / Cor:
NEGRO EPOXI
Tela / Fabric / Tissu / Tecido:
SOL or ASIENTO - NIKI or - S/B BITEK

LORETT



LORETT 84

Para el amante de las líneas rectas con tachuelas o sin ellas Lorett es apuesta segura. Con dos alturas posibles todavía se amplían las posibilidades para vestir nuestro entorno.

For the lover of straight lines with or without studs, Lorett is a safe bet. With two possible heights, the possibilities to dress our surroundings are still expanded.



LORETT 99

Pour l'amateur de lignes droites avec ou sans crampons, Lorett est une valeur sûre. Avec deux hauteurs possibles, les possibilités d'habiller notre environnement sont encore élargies.

Para os amantes das retas com ou sem tachas, a Lorett é uma aposta segura. Com duas alturas possíveis, as possibilidades de vestir o nosso entorno ainda são ampliadas.



LORETT 84

Color / Colour / Couleur / Cor:

ROBLE 680 J.C.

Tela / Fabric / Tissu / Tecido:

ATLAS 70 - ASIEN TO LUCCA 04 - S/B C&D / BITEX

TACHUELA 20 MM NÍQUEL

LORETT 84
LORETT 99

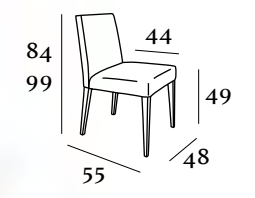

Barnizado, lacado o color muestra
Varnished, lacquered or sample colour
Vernissage laqué ou couleur de l'échantillon.
Envernizamento, lacagem ou cor da amostra

TC	SA	SB	SC	SD
300	320	340	360	380

 x1 sillas 1,60 m.	 captoné x1 sillas 2,10 m.	 x1 silla 6,60 kg.	 x2 sillas 15,7 kg.	 x2 sillas 0,44 m ³
--	--	--	---	--

OPCIONES (en puntos) / **OPTIONS** (points) / **OPTIONS** (points) / **OPÇÕES** (pontos)

1 + 0 Patas: 2,3,5 + 33 Pata: 4	2 + 95 Brazo: 1,2	3 + 0	4 - 65	5 + 10 Por unidad	6 + 25 Por unidad
7 + 10 Por unidad	9 + 30	10 + 25	11 + 60	12 + 240	13 + 90
14 GND + 125 GMT + 185	15 + 0 PMT	16 ND + 0 NDP4 + 33	17 + 0 MT		

LORET 84
Color / Colour / Couleur / Cor:
ROBLE 68o J.C.
Tela / Fabric / Tissu / Tecido:
ATLAS 7o - ASIEN TO LUCCA 04 - S/B C&D / BITEX
TACHUELA 2o MM NÍQUEL



DORA



DORA

Su decoración es totalmente manual con una tachuela doble en su respaldo que la hace diferente y coqueta. Una apuesta segura de un clásico renovado.

Its decoration is completely manual with a double tack on its back that makes it different and flirtatious. A safe bet on a renewed classic.

Sa décoration est entièrement manuelle avec un double clou au dos qui la rend différente et coquette. Une valeur sûre sur un classique renouvelé.

Sua decoração é totalmente manual com um duplo travão no verso que a torna diferente e sedutora. Uma aposta segura em um clássico renovado.



DORA

Color / Colour / Couleur / Cor:

DORADO 338-2 J.C.

Tela / Fabric / Tissu / Tecido:

BRUNEI 32 - TACHUELA 12 MM DORADA - S/B FROCA

DORA



Barnizado, lacado o color muestra

Varnished, lacquered or sample colour
Vernissage laqué ou couleur de l'échantillon.
Envernizamento, lacagem ou cor da amostra

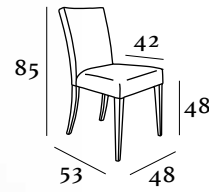

TC	SA	SB	SC	SD
310	330	350	370	390

 x1 sillas 1,60 m.	 capitoné x1 sillas 2,10 m.	 x1 silla 6,00 kg.	 x2 sillas 14,5 kg.	 x2 sillas 0,43 m³
--	---	---	---	--

OPCIONES (en puntos) / OPTIONS (points) / OPTIONS (points) / OPÇÕES (pontos)

1 + 0 Patas: 2,3,5 + 33 Pata: 4	2 + 95 Brazo: 1,2	3 + 0	4 - 65	5 + 10 Por unidad	6 + 25 Por unidad
7 + 10 Por unidad	9 + 30	10 + 25	11 + 60	12 + 240	13 + 90
14 GND + 125 GMT + 185	15 + 0 PMT	16 ND + 0 NDP4 + 33	17 + 0 MT		

DORA
Color / Colour / Couleur / Cor:
DORADO 338-2 J.C.
Tela / Fabric / Tissu / Tecido:
BRUNEI 32 - TACHUELA 12 MM DORADA
S/B FROCA

TORINO



TORINO

Líneas básicas y redondas y una estructura envolvente hacen que Torino sea cómoda y práctica una respuesta con simplicidad a diferentes cuestiones funcionales. Tanto para el hogar como para contract.

Basic round lines and an enveloping structure make Torino a comfortable and practical answer with simplicity to different functional questions. Both for home and contract.



TORINO ND

Des lignes rondes de base et une structure enveloppante font de Torino une réponse confortable et pratique avec simplicité à différentes questions fonctionnelles. À la fois pour la maison et le contrat.

Linhas arredondadas básicas e uma estrutura envolvente fazem do Torino uma resposta prática e confortável com simplicidade para diferentes questões funcionais. Tanto para casa como para contrato.



TORINO MT

TORINO MT
Color / Colour / Couleur / Cor:
BLANCO EPOXI
Tela / Fabric / Tissu / Tecido:
OASIS 03 - ASIEN TO CAMBOYA 03 - S/B EROCA

BERLÍN CENTRO - CHAPA ROBLE NATURAL
Mesas de centro / Coffee table
Table basse / Mesa de centro
Color / Colour / Couleur / Cor:
ROBLE CARAMELO J.C.



TORINO
TORINO ND

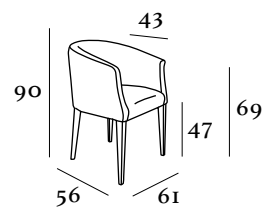

Barnizado, lacado o color muestra
Varnished, lacquered or sample colour
Vernissage laqué ou couleur de l'échantillon.
Envernizamento, lacagem ou cor da amostra

TC	SA	SB	SC	SD
322	342	362	382	402

	x1 unid.	x1 unid.	x2 unids.	x2 unids.
TORINO	1,75 m.	7,5 kg.	17,5 kg.	0,54 m ³
TORINO ND	1,75 m.	9,9 kg.	22,3 kg.	0,54 m ³

OPCIONES (en puntos) / OPTIONS (points) / OPTIONS (points) / OPÇÕES (pontos)

1 + 0	Patas: 2,3,5	3 + 0	5 + 10	6 + 25	7 + 10	9 + 30
	+ 33 Pata: 4		Por unidad	Por unidad	Por unidad	
11 + 60	10 + 25	13 + 90	14 GND + 125	15 + 0	16 ND + 0	
			GMT + 185	PMT	NDP ₄ + 33	

TORINO

Color / Colour / Couleur / Cor:
BLANCO 316 MATE J.C.
Tela / Fabric / Tissu / Tecido:
OASIS 03 - TRASERA GRAPPA 04 - S/B FROCA / BITEK

TORINO MT

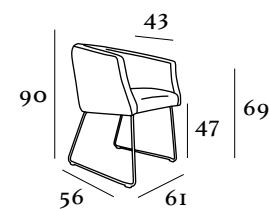

Acabados patas metal
Metal legs finishes



TC	SA	SB	SC	SD
322	342	362	382	402

	x1 unid.	x1 unid.	x2 unids.	x2 unids.
TORINO MT	1,75 m.	10,4 kg.	24,5 kg.	0,54 m ³

OPCIONES (en puntos) / OPTIONS (points) / OPTIONS (points) / OPÇÕES (pontos)

3 + 0	5 + 10	6 + 25	7 + 10	9 + 30
	Por unidad	Por unidad	Por unidad	
10 + 25	13 + 90	14 GND + 125	15 + 0	
		GMT + 185	PMT	

TORINO ND

Color / Colour / Couleur / Cor:
ROBLE 680 J.C.
Tela / Fabric / Tissu / Tecido:
OASIS 03 - ASIEN TO CAMBOYA 03 - S/B FROCA

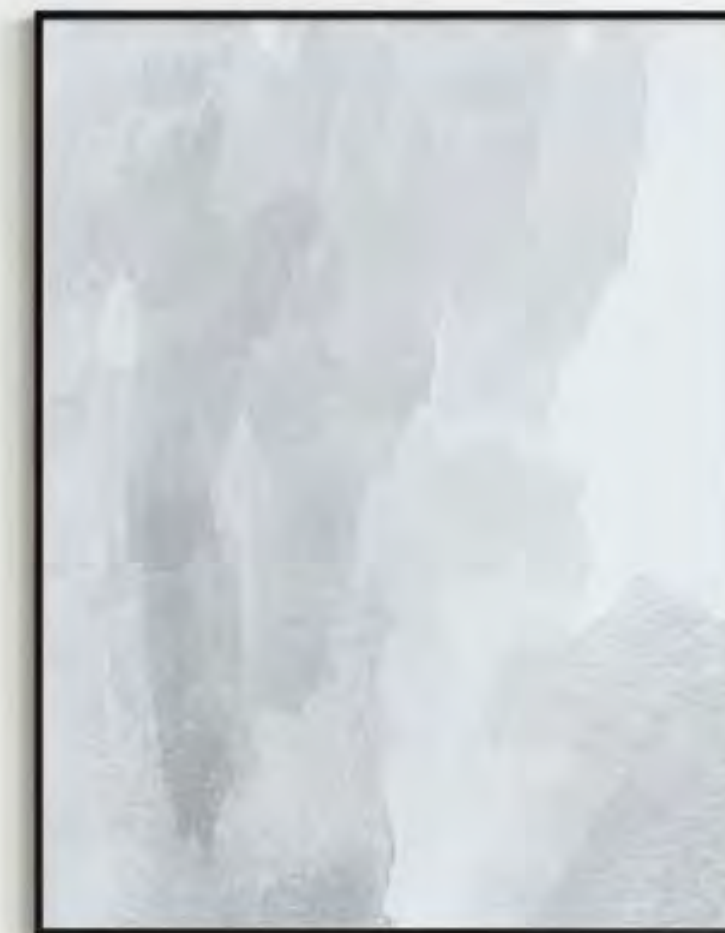

TORINO MT

Color / Colour / Couleur / Cor:
BLANCO EPOXI
Tela / Fabric / Tissu / Tecido:
OASIS 03 - ASIEN TO CAMBOYA 03 - S/B FROCA

LUXE



LUXE

El neoclasicismo personalizado se instala en tu salón. Pureza de líneas unida a la nobleza de la madera para conseguir un producto digno de cualquier hogar o colectividad.

Personalized neoclassicism is installed in your living room. Purity of lines combined with the nobility of wood to achieve a product worthy of any home or community.



LUXE CR

Le néoclassicisme personnalisé s'installe dans votre salon. Pureté des lignes combinée à la noblesse du bois pour obtenir un produit digne de n'importe quelle maison ou communauté.

O neoclassicismo personalizado está instalado na sua sala. Pureza de linhas aliada à nobreza da madeira para se chegar a um produto digno de qualquer casa ou comunidade.



LUXE CR
Color / Colour / Couleur / Cor:
BLANCO 316 MATE J.C.
Tela / Fabric / Tissu / Tecido:
CAMBOYA 03 - S/B FROCA

LUXE
LUXE CR

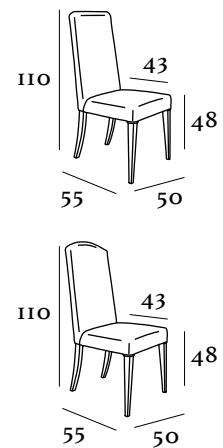

Barnizado, lacado o color muestra
Varnished, lacquered or sample colour
Vernissage laqué ou couleur de l'échantillon.
Envernizamento, lacagem ou cor da amostra

TC	SA	SB	SC	SD
276	296	316	336	356

 x1 unid. 1,70 m.	 capitone x1 sillas 2,20 m.	 x1 unid. 7,00 kg.	 x2 unids. 16,5 kg.	 x2 unids. 0,44 m³
---	---	---	---	--

OPCIONES (en puntos) / OPTIONS (points) / OPTIONS (points) / OPÇÕES (pontos)

1 + 0 Patas: 2,35	2 + 95 Brazo: 1,2	3 + 0	4 + 65	5 + 10 Por unidad	6 + 25 Por unidad
7 + 10 Por unidad	9 + 30	10 + 25	11 + 60	12 + 205	13 + 90

LUXE

Color / Colour / Couleur / Cor:
BLANCO 316 MATE J.C.
 Tela / Fabric / Tissu / Tecido:
BRUNEI 04 - ASIENTO MACAO 08 - S/B FROCA



LUXE CR

Color / Colour / Couleur / Cor:
BLANCO 316 MATE J.C.
 Tela / Fabric / Tissu / Tecido:
CAMBOYA 07 - S/B FROCA

GIO



GIO

Cuando la líneas rectas marcan la diferencia dotan de carácter a Gio para conformar una solución confortable ya sea para el hogar o para contract. La geometría transformada en confort.

When straight lines make a difference, they give Gio character to create a comfortable solution for either the home or the contract. Geometry transformed into comfort.



GIO ND

Lorsque les lignes droites font la différence, elles donnent du caractère à Gio pour créer une solution confortable pour la maison ou le contrat. La géométrie transformée en confort.

Quando as linhas retas fazem a diferença, elas dão a Gio personalidade para criar uma solução confortável para a casa ou para o contrato. Geometria transformada em conforto.



GIO MT

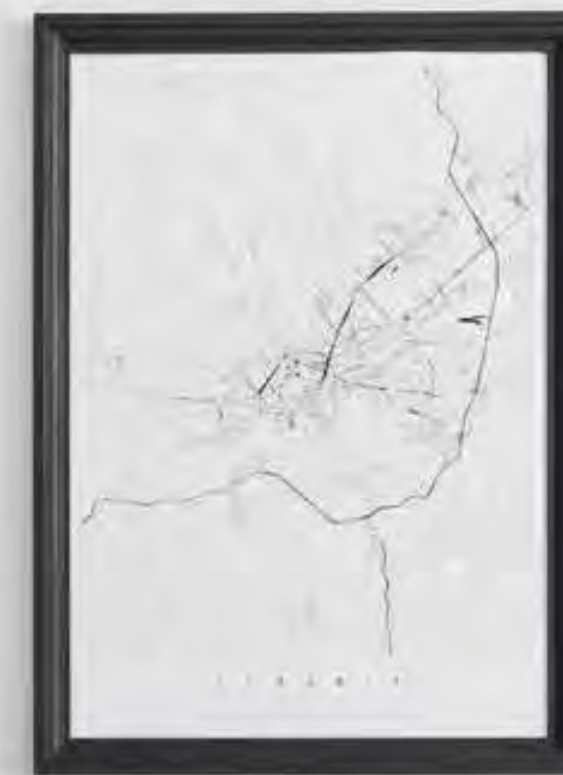

GIO ND
Color / Colour / Couleur / Cor:
ROBLE 68o J.C.
Tela / Fabric / Tissu / Tecido:
BRUNEL 34 - ASIEN TO FILA or S/B-C FROCA

GIO
GIO ND

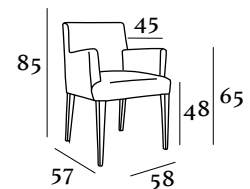

Barnizado, lacado
o color muestra
Varnished, lacquered or sample colour
Vernissage laqué ou couleur de l'échantillon.
Envernizamento, lacagem ou cor da amostra

TC	SA	SB	SC	SD
322	342	362	382	402

	x1 unid.	x1 unid.	x2 unids.	x2 unids.
GIO	1,75 m.	8,5 kg.	19,5 kg.	0,54 m ³
GIO ND	1,75 m.	10,4 kg.	23,3 kg.	0,54 m ³

OPCIONES (en puntos) / OPTIONS (points) / OPTIONS (points) / OPÇÕES (pontos)

1 + 0	Patas: 2,3,5	3 + 0	5 + 10	6 + 25	7 + 10	9 + 30
	+ 33 Pata: 4		Por unidad	Por unidad	Por unidad	
10 + 25	11 + 60	13 + 90	14 GND + 125 GMT + 185	15 + 0 PMT	16 ND + 0 NDP4 + 33	

GIO ND

Color / Colour / Couleur / Cor:
ROBLE 680 J.C.
Tela / Fabric / Tissu / Tecido:
BRUNEI 34 - TRASERA FILA 01 - S/B C FROCA



GIO MT

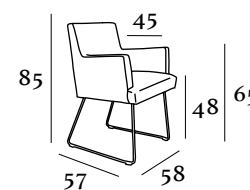

Acabados patas metal
Metal legs finishes



TC	SA	SB	SC	SD
322	342	362	382	402

	x1 unid.	x1 unid.	x2 unids.	x2 unids.
GIO MT	1,75 m.	11,0 kg.	24,5 kg.	0,54 m ³

OPCIONES (en puntos) / OPTIONS (points) / OPTIONS (points) / OPÇÕES (pontos)

3 + 0	4 + 65	5 + 10	6 + 25	7 + 10	9 + 30
		Por unidad	Por unidad	Por unidad	
10 + 25	11 + 60	13 + 90	14 GND + 125 GMT + 185	15 + 0 PMT	

GIO MT

Color / Colour / Couleur / Cor:
VULCANO TEX J.C.
Tela / Fabric / Tissu / Tecido:
BRUNEI 34 - ASIENTO FILA 01 - S/BC FROCA

NAPLES



NAPLES 84

Una silla de autor que tiene su encanto en la combinación del vivo con su ancho asiento estilo inglés. La sobriedad de formas le confiere una particular elegancia en cualquier espacio.

A signature chair that has its charm in the combination of living with its wide English-style seat. The sobriety of forms gives it a particular elegance in any space.



NAPLES 99

Une chaise signature qui a son charme dans l'alliance du living avec sa large assise de style anglais. La sobriété des formes lui confère une élégance particulière dans n'importe quel espace.

Uma cadeira exclusiva que tem seu charme na combinação de vida com seu amplo assento de estilo inglês. A sobriedade das formas confere-lhe uma elegância particular em qualquer espaço.



NAPLES 84
Color / Colour / Couleur / Cor:
BLANCO 316 MATE J.C.
Tela / Fabric / Tissu / Tecido:
OASIS 20, VIVO DOLCE 08 - S/B FROCA

NAPOLES 84
NAPOLES 99

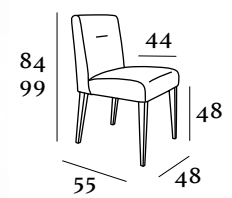

Barnizado, lacado
 o color muestra
*Varnised, lacquered or sample colour
 Vernissage laqué ou couleur de l'échantillon.
 Envernizamento, lacagem ou cor da amostra*

TC	SA	SB	SC	SD
280	300	320	340	360

x1 sillas 1,80 m.
 x1 silla 6,60 kg.
 x2 sillas 15,7 kg.
 x2 sillas 0,44 m³

OPCIONES (en puntos) / **OPTIONS** (points) / **OPTIONS** (points) / **OPÇÕES** (pontos)

- 1 + 0 Patas: 2,3,5
+ 33 Pata: 4
- 2 + 95 Brazo: 1,2,3
- 3 + 0
- 4 + 65
- 5 + 10 Por unidad
- 6 + 25 Por unidad
- 7 + 10 Por unidad
- 9 - 30
- 10 + 25
- 11 + 60
- 13 + 90
- 14 GND + 125
GMT + 185
- 15 + 0 PMT
- 16 ND + 0
NDP4 + 33
- 17 + 0 MT

NAPOLES 84
 Color / Colour / Couleur / Cor:
BLANCO 316 MATE J.C.
 Tela / Fabric / Tissu / Tecido:
OASIS 20 - VIVO DOLCE 08 - S/B FROCA

JULIETA



JULIETA

Julieta perfecta para la alta decoración bien acompañada puede hacer una estancia con un encanto especial gracias a sus desenfadas formas que le confieren un estilo divertido pero a la vez elegante.

Juliet, perfect for high-end decoration in good company, can make a room with a special charm thanks to its carefree shapes that give it a fun but elegant style.

Julieta, parfaite pour une décoration haut de gamme en bonne compagnie, peut faire une pièce avec un charme particulier grâce à ses formes insouciantes qui lui donnent un style amusant mais élégant.

Julieta, perfeita para uma decoração de alto padrão em boa companhia, pode fazer um ambiente com um charme especial graças às suas formas despreocupadas que lhe conferem um estilo divertido mas elegante.



JULIETA

Color / Colour / Couleur / Cor:
BLANCO 316 MATE J.C.
Tela / Fabric / Tissu / Tecido:
NAGORE 05 - TRASERA, LATERAL Y BOTÓN
NAGORE 01 - S/B FROCA

JULIETA

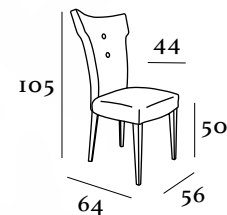

Barnizado, lacado o color muestra

Varnised, lacquered or sample colour
Vernissage laqué ou couleur de l'échantillon.
Envernizamento, lacagem ou cor da amostra

TC	SA	SB	SC	SD
356	376	396	416	436

 x1 sillas 1,70 m.	 captoné x 1 sillas 2,20 m.	 x 1 silla 6,70 kg.	 x 2 sillas 16,0 kg.	 x 2 sillas 0,44 m ³
--	---	---	--	---

OPCIONES (en puntos) / OPTIONS (points) / OPTIONS (points) / OPÇÕES (pontos)

- 1 + 0 Patas: 2,3,5
- 2 + 95 Brazo: 1,2
- 3 + 0
- 4 + 65
- 5 + 10 Por unidad
- 6 + 25 Por unidad
- 7 + 10 Por unidad
- 9 + 30
- 10 + 25
- 11 + 60
- 12 + 240
- 13 + 90

JULIETA
Color / Colour / Couleur / Cor:
BLANCO 316 MATE J.C.
Tela / Fabric / Tissu / Tecido:
NAGORE 05 - TRASERA, LATERAL Y BOTÓN
NAGORE 01 - S/B FROCA

MARINA



MARINA

Ya sea para el salón o el dormitorio Marina es un perfecto comodín debido al estilo curvado de su estructura y respaldo. Sinuosas curvas que la hacen práctica de utilizar.

Whether for the living room or bedroom, Marina is a perfect wildcard due to the curved style of its structure and backrest. Sinuous curves that make it practical to use.



MARINA ND

Que ce soit pour le salon ou la chambre, Marina est un joker parfait en raison du style incurvé de sa structure et de son dossier. Des courbes sinueuses qui le rendent pratique à utiliser.

Seja para a sala ou quarto, o Marina é um curinga perfeito pelo estilo curvo de sua estrutura e encosto. Curvas sinuosas que o tornam prático de usar.



MARINA MT



MARINA

Color / Colour / Couleur / Cor:

ROBLES 315 MATE J.C.

Tela / Fabric / Tissu / Tecido:



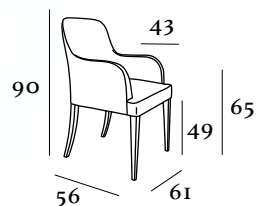

ERMES 1 - TRASERA HABANA MARINO - S/B C&O

MARINA
MARINA ND















Barnizado, lacado
o color muestra
Varnished, lacquered or sample colour
Vernissage laqué ou couleur de l'échantillon.
Envernizamento, lacagem ou cor da amostra

TC	SA	SB	SC	SD
322	342	362	382	402

				
MARINA	x1 unid. 1,75 m.	x1 unid. 8,4 kg.	x2 unids. 19,3 kg.	x2 unids 0,54 m ³
MARINA ND	1,75 m.	10,3 kg.	23,1 kg.	0,54 m ³

OPCIONES (en puntos) / OPTIONS (points) / OPTIONS (points) / OPÇÕES (pontos)

 + 0 Patas: 2,3,5	 + 0	 + 10	 + 25	 + 10	 + 30
+ 33 Patas: 4	Por unidad	Por unidad	Por unidad	Por unidad	
 + 25	 + 60	 + 90	 GND + 125 GMT + 185	 + 0 PMT	 ND + 0 NDP ₄ + 33

MARINA

Color / Colour / Couleur / Cor:
ROBLES 315 MATE J.C.
Tela / Fabric / Tissu / Tecido:
ERMES 1 - TRASERA HABANA MARINO - S/B C&O

MARINA MT





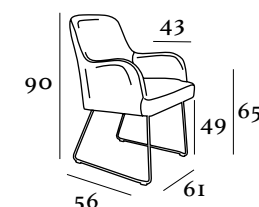







Acabados patas metal
Metal legs finishes



TC	SA	SB	SC	SD
322	342	362	382	402

				
MARINA MT	x1 unid. 1,75 m.	x1 unid. 10,9 kg.	x2 unids. 24,3 kg.	x2 unids 0,54 m ³

OPCIONES (en puntos) / OPTIONS (points) / OPTIONS (points) / OPÇÕES (pontos)

 + 0	 + 65	 + 10	 + 25	 + 10	 + 30
		Por unidad	Por unidad	Por unidad	
 + 25	 + 60	 + 90	 GND + 125 GMT + 185	 + 0 PMT	

MARINA ND

Color / Colour / Couleur / Cor:
VULCANO TEX J.C.
Tela / Fabric / Tissu / Tecido:
JUPITER 03 - ASIENTO BORIS 02 - S/B FROCA

MARINA MT

Color / Colour / Couleur / Cor:
BLANCO EPOXI
Tela / Fabric / Tissu / Tecido:
JUPITER 03 - ASIENTO BORIS 02 - S/B FROCA

CASTILLA



CASTILLA

Para los amantes del volumen y el lujo de la tachuela de 22mm en cualquier acabado cromo, oro, plata vieja, etc., que le confiere carácter y personalidad. Todo un clásico al servicio del presente.

For those who love the volume and luxury of the 22mm stud in any chrome, gold, old silver, etc. finish, which gives it character and personality. A classic at the service of the present.

Pour ceux qui aiment le volume et le luxe du plot de 22 mm dans toutes les finitions chrome, or, vieil argent, etc., ce qui lui donne caractère et personnalité. Un classique au service du présent.

Para aqueles que amam o volume e luxo do pino de 22mm em qualquer acabamento cromado, ouro, prata velha, etc., que lhe confere caráter e personalidade. Um clássico ao serviço do presente.



CASTILLA

Color / Colour / Couleur / Cor:

BLANCO 316 MATE J.C.

Tela / Fabric / Tissu / Tecido:

VOLCAN GRIS - TACHUELA 20MM NÍQUEL - S/B C&D

CASTILLA

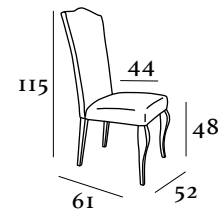

Barnizado, lacado o color muestra
 Varnished, lacquered or sample colour
 Vernissage laqué ou couleur de l'échantillon.
 Envernizamento, lacagem ou cor da amostra

TC	SA	SB	SC	SD
297	317	337	357	377

 x1 sillas 1,80 m.	 capitone x1 sillas 2,30 m.	 x1 silla 8,0 kg.	 x2 sillas 18,5 kg.	 x2 sillas 0,44 m ³
--	---	--	---	--

OPCIONES (en puntos) / OPTIONS (points) / OPTIONS (points) / OPÇÕES (pontos)

1 + 0 Patas: 1,2,3 + 33 Pata: 4	2 + 95 Brazo: 1,2	3 + 0	4 - 65	5 + 10 Por unidad	6 + 25 Por unidad
7 + 10 Por unidad	9 + 30	10 + 25	11 + 60	12 + 240	13 + 90

CASTILLA
 Color / Colour / Couleur / Cor:
BLANCO 316 MATE J.C.
 Tela / Fabric / Tissu / Tecido:
VOLCAN GRIS - S/B C&D
TACHUELA 20 MM NÍQUEL

SICILIA



SICILIA

Cuando en la sencillez está el gusto hablamos de Sicilia, escueta, elegante, sencilla pero a la vez muy completa. Su principal característica es el concepto.

When the simplicity is the taste we speak of Sicily, concise, elegant, simple but at the same time very complete. Its main feature is the concept.



SICILIA ND

Lorsque la simplicité est le goût, nous parlons de la Sicile, concise, élégante, simple mais en même temps très complète. Sa principale caractéristique est le concept.

Quando a simplicidade é o gosto falamos da Sicilia, concisa, elegante, simples mas ao mesmo tempo muito completa. Sua principal característica é o conceito.



SICILIA MT



SICILIA MT

Color / Colour / Couleur / Cor:
NEGRO EPOXI
Tela / Fabric / Tissu / Tecido:
CHARLOTTE 23 - BOTÓN BLANCO - S/B C&O



SICILIA
SICILIA ND

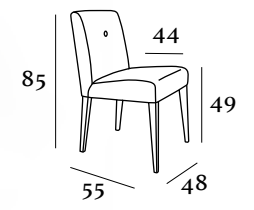

Barnizado, lacado o color muestra
Varnished, lacquered or sample colour
Verlissage laqué ou couleur de l'échantillon.
Envernizamento, lacagem ou cor da amostra

	TC	SA	SB	SC	SD
	273	293	313	333	353

	1	2	3	4	5	6	7
SICILIA	x1 unid.	x1 unid.	x2 unids.	x2 unids.			
SICILIA ND	1,40 m.	8,5 kg.	19,5 kg.	0,43 m ³			

OPCIONES (en puntos) / OPTIONS (points) / OPTIONS (points) / OPÇÕES (pontos)

- 1 + 0 Patas: 2,3,5
- 2 + 95 Brazo: 1,2,3
- 3 + 0
- 4 + 65
- 5 - 10 Por unidad
- 6 + 25 Por unidad
- 7 + 10 Por unidad
- 9 + 30
- 10 + 25
- 11 + 60
- 13 + 90
- 15 + 0 PMT
- 16 ND + 0 NDP4 + 33

SICILIA
Color / Colour / Couleur / Cor:
VULCANO TEX J.C.
Tela / Fabric / Tissu / Tecido:
CHARLOTTE 23 - BOTÓN BLANCO - S/B C&O



SICILIA ND
Color / Colour / Couleur / Cor:
ROBLE 68o J.C.
Tela / Fabric / Tissu / Tecido:
CHARLOTTE 23 - BOTÓN BLANCO - S/B C&O

SICILIA MT

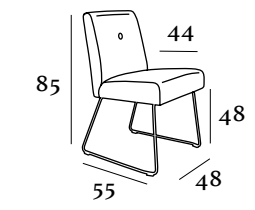

Acabados patas metal
Metal legs finishes
Negro epoxi Blanco epoxi Cromo Oro epoxi

	TC	SA	SB	SC	SD
	273	293	313	333	353

	1	2	3	4	5	6	7
SICILIA MT	x1 unid.	x1 unid.	x2 unids.	x2 unids.			
	1,40 m.	11,0 kg.	24,5 kg.	0,43 m ³			

OPCIONES (en puntos) / OPTIONS (points) / OPTIONS (points) / OPÇÕES (pontos)

- 2 + 95 Brazo: 1,2,3
- 3 + 0
- 4 + 65
- 5 - 10 Por unidad
- 6 + 25 Por unidad
- 7 + 10 Por unidad
- 9 + 30
- 10 + 25
- 11 + 60
- 13 + 90
- 14 GND + 125 GMT + 185
- 15 + 0 PMT



SICILIA MT
Color / Colour / Couleur / Cor:
NEGRO EPOXI
Tela / Fabric / Tissu / Tecido:
CHARLOTTE 23, BOTÓN BLANCO - S/B C&O

VERONA
MARSELLA



VERONA

¿Quieres convertir tu salón en un espacio de lujo a tu alcance? Verona y Marsella están dispuestas a ello. Con una altura de 120 cm, consigue la comodidad deseada y además estar a la "altura".

Do you want to turn your living room into a luxury space at your fingertips? Verona and Marseille are ready for it. With a height of 120 cm, it achieves the desired comfort and also be at the "height".



MARSELLA

Vous souhaitez transformer votre salon en un espace de luxe à portée de main ? Vérone et Marseille y sont prêtes. D'une hauteur de 120 cm, il permet d'obtenir le confort souhaité et d'être également à la « hauteur ».

Quer transformar sua sala em um espaço de luxo ao seu alcance? Verona e Marselha estão preparadas para isso. Com uma altura de 120 cm, consegue o conforto pretendido e também estar na "altura".



VERONA
Color / Colour / Couleur / Cor:
ARENA MATE 853 J.C.
Tela / Fabric / Tissu / Tecido:
FUGI 18 - S/B FROCA - TACHUELA NIQUEL 20 MM

ROMA COMEDOR - 160X90 - 2 EXT 40 CM
Mesa / Table / Table / Mesa
Color / Colour / Couleur / Cor:
LACADO ARENA 680 MATE J.C.
PATAS WENGUE 311 J.C.

VERONA

MARSELLA

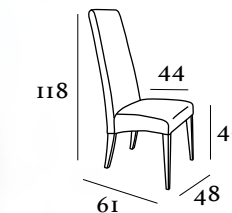
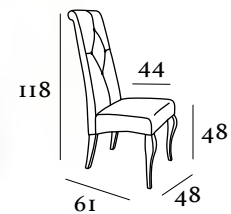

Barnizado, lacado o color muestra
 Varnished, lacquered or sample colour
 Vernissage laqué ou couleur de l'échantillon.
 Envernizamento, lacagem ou cor da amostra

Barnizado, lacado o color muestra
 Varnished, lacquered or sample colour
 Vernissage laqué ou couleur de l'échantillon.
 Envernizamento, lacagem ou cor da amostra

TC	SA	SB	SC	SD
490	510	533	553	576

TC	SA	SB	SC	SD
316	336	356	376	396

-  x1 sillas 1,90 m.
-  x1 sillas 2,40 m.
-  x1 silla 8,0 kg.
-  x2 sillas 18,5 kg.
-  x2 sillas 0,56 m³

-  x1 sillas 1,90 m.
-  x1 sillas 2,40 m.
-  x1 silla 9,2 kg.
-  x2 sillas 20,9 kg.
-  x2 sillas 0,56 m³

OPCIONES (en puntos) / OPTIONS (points) / OPTIONS (points) / OPÇÕES (pontos)

- 1** + 0 Patas: 1,2,3
- 2** + 95 + 33 Pata: 4
- 3** + 0 Brazo: 1,2,3
- 4** - 65 Por unidad
- 5** - 10 Por unidad
- 6** + 25 Por unidad
- 7** + 10 Por unidad
- 9** + 30
- 10** - 25
- 11** + 60
- 12** + 240
- 13** + 90

OPCIONES (en puntos) / OPTIONS (points) / OPTIONS (points) / OPÇÕES (pontos)

- 1** + 0 Patas: 2,3,5
- 2** + 95 + 33 Pata: 4
- 3** + 0 Brazo: 1,2
- 4** + 65 Por unidad
- 5** + 10 Por unidad
- 6** + 25 Por unidad
- 7** + 10 Por unidad
- 9** + 30
- 10** + 25
- 11** + 60
- 12** + 240
- 13** + 90

VERONA
 Color / Colour / Couleur / Cor:
ARENA 853 J.C.
 Tela / Fabric / Tissu / Tecido:
FUGI 18 - TACHUELA 20MM NÍQUEL - S/B FROCA

MARSELLA
 Color / Colour / Couleur / Cor:
VULCANO TEX J.C.
 Tela / Fabric / Tissu / Tecido:
BRÚNEI 08 - TRASERA Y LATERAL CALIPSO or S/B FROCA - C&O

CANCUN



CANCUN

Diferente y práctica, donde combinando curvas con sutiles recta y el detalle del vivo le confieren carácter además de lograr una gran comodidad.

Different and practical, where combining curves with subtle straight lines and the detail of the piping give it character as well as achieving great comfort.



CANCUN ND

Différente et pratique, où l'association des courbes avec des lignes droites subtiles et le détail du passepoil lui donnent du caractère tout en procurant un grand confort.

Diferente e prático, onde a combinação de curvas com linhas retas sutis e o detalhamento do debrum lhe conferem caráter além de alcançar grande conforto.



CANCUN MT



CANCUN ND

Color / Colour / Couleur / Cor:

ROBLE 315 J.C.

Tela / Fabric / Tissu / Tecido:

LENNON GRIS 09 - VIVO DOLCE 08 - S/B C&O - FROCA

CANCUN
CANCUN ND

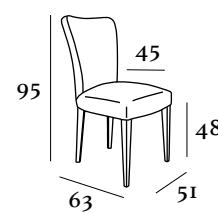

Barnizado, lacado o color muestra
Varnished, lacquered or sample colour
Vernissage laqué ou couleur de l'échantillon.
Envernizamento, lacagem ou cor da amostra

TC	SA	SB	SC	SD
355	375	395	415	435

	x1 unid.	x1 unid.	x2 unids.	x2 unids.
CANCUN	1,70 m.	6,1 kg.	14,7 kg.	0,43 m ³
CANCUN ND	1,70 m.	8,1 kg.	18,7 kg.	0,43 m ³

OPCIONES (en puntos) / OPTIONS (points) / OPTIONS (points) / OPÇÕES (pontos)

1 + 0	Patas: 2,3,5	2 + 95	3 + 0	4 + 65	5 + 10	6 + 25	7 + 10
+ 33	Patá: 4	Brazo: 1,2,7,8		Por unidad	Por unidad	Por unidad	Por unidad
9 - 30	10 + 25	11 + 60	13 + 90	14 GND + 125 GMT + 185	16 ND + 0 NDP4 + 33		

CANCUN ND

Color / Colour / Couleur / Cor:
ROBLE 315 J.C.
Tela / Fabric / Tissu / Tecido:
LENNON SKY 20 - VIVO DOLCE 08 - S/B C&O - FROCA

CANCUN MT

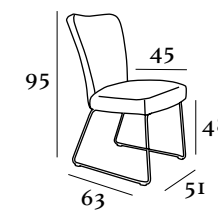

Acabados patas metal
Metal legs finishes



TC	SA	SB	SC	SD
355	375	395	415	435

	x1 unid.	x1 unid.	x2 unids.	x2 unids.
CANCUN MT	1,70 m.	8,6 kg.	19,7 kg.	0,43 m ³

OPCIONES (en puntos) / OPTIONS (points) / OPTIONS (points) / OPÇÕES (pontos)

2 + 95	3 + 0	4 + 65	5 + 10	6 + 25	7 + 10	9 + 30
Brazo: 7,8		Por unidad	Por unidad	Por unidad	Por unidad	
10 + 25	11 + 60	13 + 90	14 GND + 125 GMT + 185	15 + 0 PMT		

CANCUN MT- Color / Colour / Couleur / Cor:
BLANCO EPOXI
Tela / Fabric / Tissu / Tecido:
LENNON GRIS 09 - VIVO DOLCE 08 - S/B C&O - FROCA

VIENA



VIENA - 90

Un semibrazo con encanto, su amplitud y comodidad la hacen un modelo muy demandado. Disponible en dos alturas para poder elegir la que mejor se adapte a tus necesidades.

A charming semi-arm, its spaciousness and comfort make it a highly demanded model. Available in two heights to be able to choose the one that best suits your needs.



VIENA - 100

Charmant demi-bras, son espace et son confort en font un modèle très demandé. Disponible en deux hauteurs pour pouvoir choisir celle qui convient le mieux à vos besoins.

Um charmoso semi-braço, sua amplitude e conforto tornam-no um modelo muito requisitado. Disponível em duas alturas para poder escolher a que melhor se adapta às suas necessidades.



VIENA 90

Color / Colour / Couleur / Cor:

BLANCO 316 MATE J.C.

Tela / Fabric / Tissu / Tecido:

THALYS 03 VIVO DOLCE 08 - S/B FROCA - C&O

VIENA 90
VIENA 100

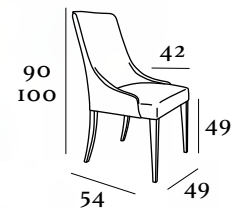

Barnizado, lacado o color muestra

Varnished, lacquered or sample colour
Vernissage laqué ou couleur de l'échantillon.
Envernizamento, lacagem ou cor da amostra

TC	SA	SB	SC	SD
363	383	403	423	443

x1 sillas 1,75 m.	capitón x 1 sillas 2,25 m.	x 1 silla 8,5 kg.	x 2 sillas 19,5 kg.	x 2 sillas 0,44 m ³
----------------------	-------------------------------	----------------------	------------------------	-----------------------------------

OPCIONES (en puntos) / OPTIONS (points) / OPTIONS (points) / OPÇÕES (pontos)

1 + 0 Patas: 2,3,5 + 33 Pata: 4	2 + 95 Brazo: 1,2,3	3 + 0	4 + 65	5 + 10 Por unidad	6 + 25 Por unidad
7 + 10 Por unidad	9 - 30	10 + 25	11 + 60	12 + 240	13 + 90
14 GND + 125 GMT + 185	15 + 0 PMT	16 ND + 0 NDP4 + 33	17 + 0 MT		



VIENA - 100
Color / Colour / Couleur / Cor:
VULCANO TEX J.C.
Tela / Fabric / Tissu / Tecido:
MAGIA 26 - VIVO ZOE 14 - S/B S.TEXTIL - FROCA

ALEX



ALEX

Estilo sobrio, líneas rectas y curvas componen la estética de Alex. Funcional y al mismo tiempo elegante a la vez que muy cómoda debido al tapizado envolvente de todo el perímetro.

Sober style, straight lines and curves make up Alex's aesthetic. Functional and at the same time elegant as well as very comfortable due to the wraparound upholstery around the perimeter.



ALEX ND

Style sobre, lignes droites et courbes composent l'esthétique d'Alex. Fonctionnel et en même temps élégant ainsi que très confortable grâce au rembourrage enveloppant autour du périmètre.

Estilo sóbrio, linhas retas e curvas compõem a estética de Alex. Funcional e ao mesmo tempo elegante e muito confortável devido ao estofamento envolvente em todo o perímetro.



ALEX MT



INDO - CENTRO
Color / Colour / Couleur / Cor:
TAPA BLANCO 316 MATE J.C.
PATASROBLE 680 J.C.

ALEX ND
Color / Colour / Couleur / Cor:
BLANCO 316 MATE J.C.
Tela / Fabric / Tissu / Tecido:
BRUNEI 30 - TRASERA CROSS ROCA - S/B FROCA - C&O

ALEX
ALEX ND

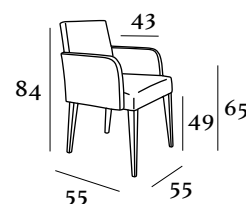

Barnizado, lacado
o color muestra

Varnished, lacquered or sample colour
Vernissage laqué ou couleur de l'échantillon.
Envernizamento, lacagem ou cor da amostra

TC	SA	SB	SC	SD
322	342	362	382	402

	x1 unid.	x1 unid.	x2 unids.	x2 unids
ALEX	1,75 m.	10,0 kg.	19,3 kg.	0,54 m ³
ALEX ND	1,75 m.	12,0 kg.	23,1 kg.	0,54 m ³

OPCIONES (en puntos) / OPTIONS (points) / OPTIONS (points) / OPÇÕES (pontos)

1 + 0 Patas: 2,3,5	3 + 0	4 + 65	5 + 10	6 + 25	7 + 10	9 + 30
+ 33 Pata: 4			Por unidad	Por unidad	Por unidad	
10 + 25	11 + 60	13 + 90	14 GND + 125 GMT + 185	15 + 0 PMT	16 ND + 0 NDP4 + 33	



ALEX ND

Color / Colour / Couleur / Cor:
BLANCO 316 MATE J.C.
Tela / Fabric / Tissu / Tecido:
BRUNEI 30 - TRASERA CROSS ROCA - S/B FROCA - C&O

ALEX MT

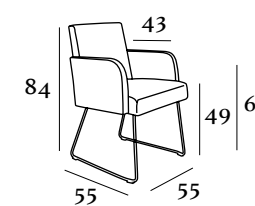

Acabados patas metal

Metal legs finishes



TC	SA	SB	SC	SD
322	342	362	382	402

	x1 unid.	x1 unid.	x2 unids.	x2 unids
ALEX MT	1,75 m.	12,5 kg.	24,3 kg.	0,54 m ³

OPCIONES (en puntos) / OPTIONS (points) / OPTIONS (points) / OPÇÕES (pontos)

3 + 0	4 + 65	5 + 10	6 + 25	7 + 10	9 + 30
		Por unidad	Por unidad	Por unidad	
10 + 25	11 + 60	13 + 90	14 GND + 125 GMT + 185	15 + 0 PMT	



ALEX MT

Color / Colour / Couleur / Cor:
NEGRO EPOXI
Tela / Fabric / Tissu / Tecido:
BRUNEI 30 - TRASERA CROSS ROSA - S/B FROCA - C&O

MADEIRA
LISBOA



MADEIRA SILLA



MADEIRA SILLÓN



LISBOA SILLA



LISBOA SILLÓN

Si eres un apasionado de las líneas clásicas Madeira y Lisboa son dos buenas opciones para completar tu hogar. Un claro ejemplo de que lo clásico puede convertirse en actual ayudada por su ligero toque actualizado.

If you are passionate about classic lines, Madeira and Lisbon are two good options to complete your home. A clear example that the classic can become current helped by its light updated touch.

Si vous êtes passionné par les lignes classiques, Madère et Lisbonne sont deux bonnes options pour compléter votre maison. Un exemple clair que le classique peut devenir actuel aidé par sa légère touche mise à jour.

Se é apaixonado pelas linhas clássicas, Madeira e Lisboa são duas boas opções para completar a sua casa. Um exemplo claro de que o clássico pode se tornar atual ajudado por seu toque leve e atualizado.



MADEIRA SILLA
Color / Colour / Couleur / Cor:
BLANCO VIEJO 332 J.C.
Tela / Fabric / Tissu / Tecido:
BORIS 02 - S/B FROCA

MADEIRA SILLÓN
Color / Colour / Couleur / Cor:
BLANCO VIEJO 332 J.C.
Tela / Fabric / Tissu / Tecido:
BORIS 02 - S/B FROCA

MADEIRA
SILLA
SILLÓN

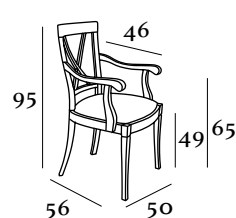
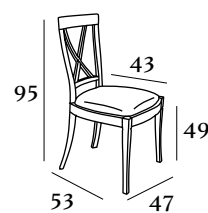

Barnizado, lacado
o color muestra
Varnished, lacquered or sample colour
Vernissage laqué ou couleur de l'échantillon.
Envernizamento, lacagem ou cor da amostra

	TC	SA	SB	SC	SD
SILLA	402	422	442	462	482
SILLÓN	497	519	539	559	579

	x1 sillas	x1 silla	x2 sillas	x2 sillas
SILLA	0,90 m.	7,0 kg.	16,5 kg.	0,43 m ³
SILLÓN	0,90 m.	8,0 kg.	18,5 kg.	0,53 m ³

OPCIONES (en puntos) / OPTIONS (points) / OPTIONS (points) / OPÇÕES (pontos)

8 + 25 | 9 + 30

MADEIRA SILLÓN
Color / Colour / Couleur / Cor:
BLANCO VIEJO 332 J.C.
Tela / Fabric / Tissu / Tecido:
BORIS 02 - S/B FROCA

LISBOA
SILLA
SILLÓN

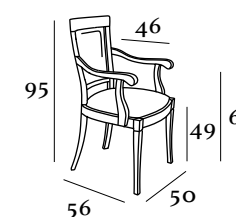
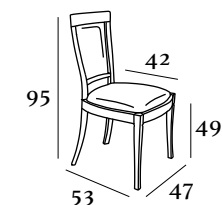

Barnizado, lacado
o color muestra
Varnished, lacquered or sample colour
Vernissage laqué ou couleur de l'échantillon.
Envernizamento, lacagem ou cor da amostra

	TC	SA	SB	SC	SD
SILLA	402	422	442	462	482
SILLÓN	497	519	539	559	579

	x1 sillas	capitoné x1 sillas	x1 silla	x2 sillas	x2 sillas
SILLA	1,20 m.	1,70 m.	7,5 kg.	17,5 kg.	0,43 m ³
SILLÓN	1,20 m.	1,70 m.	8,5 kg.	19,5 kg.	0,53 m ³

OPCIONES (en puntos) / OPTIONS (points) / OPTIONS (points) / OPÇÕES (pontos)

3 + 0 | 4 + 65 | 5 + 10 | 6 + 25 | 7 + 10 | 9 + 30
Por unidad | Por unidad | Por unidad
11 + 60 | 12 + 140

LISBOA SILLÓN
Color / Colour / Couleur / Cor:
BLANCO VIEJO 332 J.C.
Tela / Fabric / Tissu / Tecido:
NAGORE 20 - S/B FROCA

SOFIA



SOFIA

El concepto de butaca llevado a la máxima comodidad. Dale carácter a tu salón o dormitorio con Sofia, un modelo con unas dimensiones perfectas.

The armchair concept brought to maximum comfort. Give character to your living room or bedroom with Sofia, a model with perfect dimensions.



SOFIA MT

Le concept de fauteuil porté au maximum de confort. Donnez du caractère à votre salon ou votre chambre avec Sofia, un modèle aux dimensions parfaites.

O conceito de poltrona trazido ao máximo conforto. Dê personalidade à sua sala ou quarto com Sofia, um modelo com dimensões perfeitas.



SOFIA

Color / Colour / Couleur / Cor:
ROBLE 680 J.C.
Tela / Fabric / Tissu / Tecido:
ZEUS 15 - EXTERIOR ROXY 01 - S/BC FROCA

MOSCÚ CENTRO - CHAPA ROBLE NATURAL SALVAJE

Mesas de centro / Coffee table
Table basse / Mesa de centro
Color / Colour / Couleur / Cor:
ROBLE NUDO SALVAJE J.C.

SOFIA
SOFIA MT

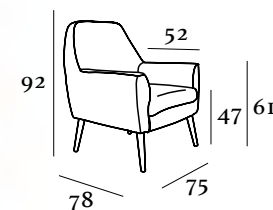

Acabados patas metal
Metal legs finishes



Barnizado, lacado
o color muestra

Varnised, lacquered or sample colour
Vernissage laqué ou couleur de l'échantillon.
Envernizamento, lacagem ou cor da amostra

TC SA SB SC SD

SOFIA 656 696 736 776 816

SOFIA MT 906 946 986 1.056 1.096

	 x1 sillas	 x1 silla	 x2 sillas	 x2 sillas
SOFIA	2,90 m.	13,5 kg.	16,5 kg.	0,59 m ³
SOFIA MT	2,90 m.	22,0 kg.	18,5 kg.	0,59 m ³



OPCIONES (en puntos) / OPTIONS (points) / OPTIONS (points) / OPÇÕES (pontos)

- 3 + 0
 - 4 + 65
 - 5 + 10
 - 6 + 25
 - 7 - 10
 - 9 - 30
-
- 10 + 25
 - 13 + 90

SOFIA

Color / Colour / Couleur / Cor:

ROBLE 68o J.C.

Tela / Fabric / Tissu / Tecido:

ZEUS 15 - EXTERIOR ROXY 01 - S/B-C FROCA

SOFIA MT

Color / Colour / Couleur / Cor:

NEGRO EPOXI

Tela / Fabric / Tissu / Tecido:

GRETA 05 MENTA - ASIENTO OSLO 06 - S/B C&O - FROCA

VICTORIA



VICTORIA

La Comodidad en espacio reducido, Victoria y su versatilidad en el uso de distintos espacios hacen que se pueda utilizar en estancias tanto de lectura, como salones, dormitorios, halls, etc.

The Comfort in reduced space, Victoria and its versatility in the use of different spaces mean that it can be used in both reading rooms, living rooms, bedrooms, halls, etc.

Le confort dans l'espace réduit, Victoria et sa polyvalence dans l'utilisation de différents espaces permettent de l'utiliser aussi bien dans les salles de lecture, les salons, les chambres, les couloirs, etc.

O Conforto em espaço reduzido, Victoria e a sua versatilidade na utilização de diferentes espaços fazem com que possa ser utilizado tanto em salas de leitura, como em salas, quartos, halls, etc.



VICTORIA

Color / Colour / Couleur / Cor: VULCANO TEX J.C.
Tela / Fabric / Tissu / Tecido: ETRO ARENA - S/B C&O

TEMPO CENTRO - CHAPA NOGAL AMERICANO

Mesas de centro / Coffee table
Table basse / Mesa de centro
Color / Colour / Couleur / Cor: NOGAL AMERICANO 335 J.C.
PATAS VULCANO TEX J.C.



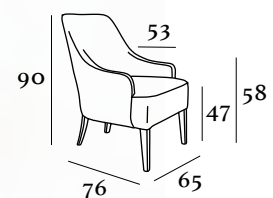

VICTORIA



Barnizado, lacado
o color muestra

Varnised, lacquered or sample colour
Vernissage laqué ou couleur de l'échantillon.
Envernizamento, lacagem ou cor da amostra

TC	SA	SB	SC	SD
550	590	630	670	710

 x1 sillas 2,75 m.	 x1 silla 12,0 kg.	 x2 sillas 14,0 kg.	 x2 sillas 0,50 m ³
--	--	---	--



OPCIONES (en puntos) / OPTIONS (points) / OPTIONS (points) / OPÇÕES (pontos)

1 + 33 Patás: 4	3 + 0	4 + 65	5 + 10 Por unidad	6 + 25 Por unidad	7 + 10 Por unidad
9 - 30	10 + 25	11 + 60	13 + 90		

VICTORIA
Color / Colour / Couleur / Cor:
VULCANO TEX J.C.
Tela / Fabric / Tissu / Tecido:
ETRO ARENA - S/B C&O

SENA



SENA

Cuando la pasión, la funcionalidad y la comodidad se unen nace Sena, una butaca multifuncional. Tradicional en su estilo y con una estructura elegante para formar parte de cualquier espacio.

When passion, functionality and comfort come together, Sena is born, a multifunctional armchair. Traditional in its style and with an elegant structure to be part of any space.

Quand passion, fonctionnalité et confort se rencontrent, Sena est né, un fauteuil multifonctionnel. Traditionnel dans son style et avec une structure élégante pour faire partie de n'importe quel espace.

Quando paixão, funcionalidade e conforto se unem, nasce Sena, uma poltrona multifuncional. Tradicional no seu estilo e com uma estrutura elegante para fazer parte de qualquer espaço.



SENA

Color / Colour / Couleur / Cor:
VULCANO TEX J.C.
Tela / Fabric / Tissu / Tecido:
LUXE PLATA - VIVO ERMES ANTRACITA - S/B C&O

TEMPO CENTRO
CHAPA NOGAL AMERICANO NATURAL
Mesas de centro / Coffee table
Table basse / Mesa de centro
Color / Colour / Couleur / Cor:
NOGAL AMERICANO 348 J.C.
PATAS VULCANO TEX J.C.

SENA

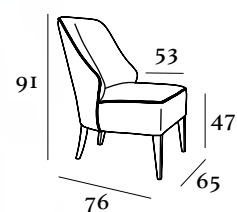

Barnizado, lacado
o color muestra
*Varnised, lacquered or sample colour
Vernissage laqué ou couleur de l'échantillon.
Envernizamento, lacagem ou cor da amostra*

TC	SA	SB	SC	SD
550	590	630	670	710

x1 sillas 2,75 m.	x 1 silla 12,0 kg.	x 2 sillas 14,0 kg.	x 2 sillas 0,50 m ³
----------------------	-----------------------	------------------------	-----------------------------------

OPCIONES (en puntos) / OPTIONS (points) / OPTIONS (points) / OPÇÕES (pontos)

1 + 33 <small>Patás: 4</small>	3 + 0	4 + 65 <small>Por unidad</small>	5 + 10 <small>Por unidad</small>	6 + 25 <small>Por unidad</small>	7 + 10 <small>Por unidad</small>
9 - 30	10 + 25	11 + 60	13 + 90		

SENA
Color / Colour / Couleur / Cor:
VULCANO TEX J.C.
Tela / Fabric / Tissu / Tecido:
LUXE PLATA - VIVO HERMES ANTRACITA - S/B C&O



IZAN



IZAN

Amplia comfortable, todo un buque insignia de el confort en su máximo esplendor. Izan atrevido y seductor, y que gracias su pie metálico le dota de una espontánea elegancia.

Spacious comfortable, a flagship of comfort at its best. She is daring and seductive, and thanks to her metallic foot, she is endowed with spontaneous elegance.

Spacieux et confortable, un fleuron du confort à son meilleur. Izan est audacieux et séduisant, et grâce à son pied métallique, il lui donne une élégance spontanée.

Espaçoso e confortável, o carro-chefe do conforto no que há de melhor. Izan é ousada e sedutora e, graças ao seu pé metálico, confere-lhe uma elegância espontânea.



IZAN

Color / Colour / Couleur / Cor:
NEGRO EPOXI

Tela / Fabric / Tissu / Tecido:
LUXE 02 PULPURA - EXTERIOR PAPAGAYO MOSTAZA - S/B C&O

IZAN

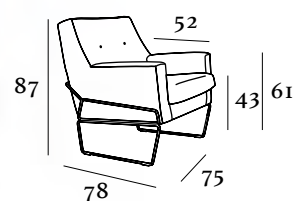

Acabados patas metal
Metal legs finishes



Negro epoxi Blanco epoxi Cromo Oro epoxi

TC	SA	SB	SC	SD
906	946	986	1.056	1.096

x1 sillas 2,90 m.	x1 silla 21,4 kg.	x2 sillas 23,9 kg.	x2 sillas 0,59 m ³
----------------------	----------------------	-----------------------	----------------------------------

OPCIONES (en puntos) / OPTIONS (points) / OPTIONS (points) / OPÇÕES (pontos)

3 + 0 | 4 + 65 | 5 + 10 | 6 + 25 | 7 ± 10 | 10 + 25
Por unidad Por unidad Por unidad Por unidad

IZAN
Color / Colour / Couleur / Cor:
NEGRO EPOXI
Tela / Fabric / Tissu / Tecido:
LUXE 02 PULPURA -
EXTERIOR PAPAGAYO MOSTAZA - S/B C&O



PERSIA
ALHAMBRA
OPORTO



PERSIA
60 - 80 - 100



ALHAMBRA
60 - 80 - 100



OPORTO
90 - 110 - 130

Banquetas para cualquier tipo de dormitorio, a pie de cama o para cualquier vestidor tres modelos, tres estilos, tres opciones, inspirados en los bancos tradicionales que serán perfectas para ti.

Benches for any type of bedroom, at the foot of the bed or for any dressing room three models, three styles, three options, inspired by traditional benches that will be perfect for you.

Bancs pour tout type de chambre, au pied du lit ou pour tout dressing trois modèles, trois styles, trois options, inspirés des bancs traditionnels qui vous conviendront parfaitement.

Bancos para qualquer tipo de quarto, ao pé da cama ou para qualquer camarim três modelos, três estilos, três opções, inspirados nos bancos tradicionais que vão ser perfeitos para si.



ALHAMBRA 100
Color / Colour / Couleur / Cor:
BLANCO 316 MATE J.C.
Tela / Fabric / Tissu / Tecido:
BIRMANIA 39 - S/C FROCA

PERSIA
60-80-100
ALHAMBRA
60-80-100
OPORTO
90-110-130



PERSIA P1 100
Color / Colour / Couleur / Cor:
ROBLE 315 J.C.
Tela / Fabric / Tissu / Tecido:
LUXE SKY - S/B C&O



ALHAMBRA ND P4 100
Color / Colour / Couleur / Cor:
ROBLE 680 J.C.
Tela / Fabric / Tissu / Tecido:
BIRMANIA 33 - S/C FROCA



OPORTO P5 110
Color / Colour / Couleur / Cor:
NOGAL 300 J.C.
Tela / Fabric / Tissu / Tecido:
GARE SALMÓN - S/B CURDEC

PERSIA P1

Barnizado, lacado
o color muestra

Varnished, lacquered or sample colour
Vernissage laqué ou couleur de l'échantillon.
Envernizamento, lacagem ou cor da amostra

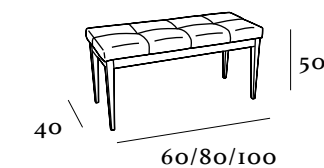

	TC	SA	SB	SC	SD
60	327	339	359	379	399
80	361	373	393	413	433
100	395	407	427	447	467

60	x1 unid. 0,75 m.	x1 unid. 7,0 kg.	x1 unid. 9,0 kg.	x1 unid. 0,13 m ³
80	0,75 m.	8,0 kg.	10,0 kg.	0,20 m ³
100	0,75 m.	9,0 kg.	11,0 kg.	0,25 m ³

OPCIONES (en puntos) / **OPTIONS** (points) / **OPÇÕES** (pontos)

1 + 0 Patas: 2,35 | **3** + 0 | **4** + 65 | **5** + 10 | **6** + 25 | **10** - 25
Por unidad Por unidad

ALHAMBRA ND P4

Barnizado, lacado
o color muestra

Varnished, lacquered or sample colour
Vernissage laqué ou couleur de l'échantillon.
Envernizamento, lacagem ou cor da amostra

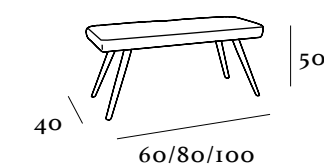

	TC	SA	SB	SC	SD
60	327	339	359	379	399
80	361	373	393	413	433
100	395	407	427	447	467

60	x1 unid. 0,75 m.	x1 unid. 9,0 kg.	x1 unid. 11,0 kg.	x1 unid. 0,13 m ³
80	0,75 m.	10,0 kg.	12,0 kg.	0,20 m ³
100	0,75 m.	11,0 kg.	13,0 kg.	0,25 m ³

OPCIONES (en puntos) / **OPTIONS** (points) / **OPÇÕES** (pontos)

3 + 0 | **4** + 65 | **5** + 10 | **6** + 25 | **7** + 10
Por unidad Por unidad Por unidad
10 + 25 | **11** + 60 | **16** ND + 0
NDP4 + 33

OPORTO P5

Barnizado, lacado
o color muestra

Varnished, lacquered or sample colour
Vernissage laqué ou couleur de l'échantillon.
Envernizamento, lacagem ou cor da amostra

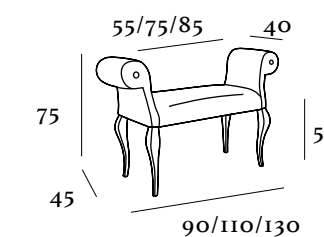

	TC	SA	SB	SC	SD
90	427	448	468	488	508
110	461	482	502	522	542
130	495	516	536	556	576

90	x1 unid. 2,50 m.	x1 unid. 9,0 kg.	x1 unid. 11,0 kg.	x1 unid. 0,15 m ³
110	2,50 m.	10,0 kg.	12,0 kg.	0,22 m ³
130	2,50 m.	11,0 kg.	13,0 kg.	0,30 m ³

OPCIONES (en puntos) / **OPTIONS** (points) / **OPÇÕES** (pontos)

1 + 0 Patas: 1 | **3** + 0 | **4** + 65 | **5** + 10 | **6** + 25 | **11** + 60
Por unidad Por unidad

DEXTER
OSLO



**TABURETE
DEXTER 2.0 H60
DEXTER 2.0 H80**

Amplios, con dos alturas disponibles, indispensables para acompañarnos en nuestras reuniones culinarias en barra o península. Cómodos y elegantes.

Spacious, with two available heights, essential to accompany us in our culinary meetings in the bar or on the peninsula. Comfortable and elegant.



**TABURETE
OSLO H60
OSLO H80**

Spacieux, avec deux hauteurs disponibles, indispensable pour nous accompagner dans nos rendez-vous culinaires au bar ou sur la presqu'île. Confortable et élégant.

Amplo, com duas alturas disponíveis, imprescindível para nos acompanhar em nossos encontros gastronômicos no bar ou na península. Confortável e elegante.



**TABURETE
OSLO MT H60
OSLO MT H80**



TABURETE OSLO H60
Color / Colour / Couleur / Cor:
ROBLE 315 J.C.
Tela / Fabric / Tissu / Tecido:
GRETA 05 MENTA - VIVO GRETA 16 AZAFATA - S/B C&O

OSLO H6o
OSLO H8o
OSLO MT H6o
OSLO MT H8o

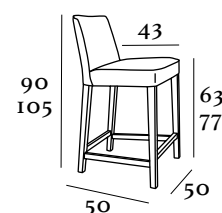
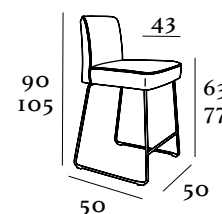





Acabados patas metal
Metal legs finishes



Barnizado, lacado
o color muestra

Varnised, lacquered or sample colour
Vernissage laqué ou couleur de l'échantillon.
Emvernizamento, lacagem ou cor da amostra

TC	SA	SB	SC	SD
437	457	477	497	517

				
OSLO	x1 unid. 1,50 m.	x1 unid. 7,5 kg.	x1 unid. 10,0 kg.	x1 unid. 0,30 m ³
OSLO MT	x1 unid. 1,50 m.	x1 unid. 9,5 kg.	x1 unid. 12,0 kg.	x1 unid. 0,30 m ³

OPCIONES (en puntos) / OPTIONS (points) / OPTIONS (points) / OPÇÕES (pontos)

3 + 0	4 + 65	5 + 10	6 + 25	7 + 10	9 - 30
	Por unidad	Por unidad	Por unidad	Por unidad	
10 + 25	11 + 60	13 + 90			



TABURETE OSLO H6o

Color / Colour / Couleur / Cor:
ROBLE 315 J.C.
Tela / Fabric / Tissu / Tecido:
GRETA 05 MENTA - VIVO GRETA 16 AZAFATA - S&B C&O

DEXTER H6o
DEXTER H8o

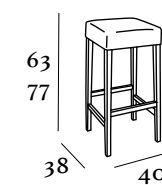

Barnizado, lacado
o color muestra

Varnised, lacquered or sample colour
Vernissage laqué ou couleur de l'échantillon.
Emvernizamento, lacagem ou cor da amostra

TC	SA	SB	SC	SD
334	354	374	394	414

				
	x1 unid. 1,00 m.	x1 unid. 5,5 kg.	x1 unid. 8,0 kg.	x1 unid. 0,15 m ³

OPCIONES (en puntos) / OPTIONS (points) / OPTIONS (points) / OPÇÕES (pontos)

3 + 0	4 + 65	5 + 10	6 + 25	7 + 10	9 + 30
	Por unidad	Por unidad	Por unidad	Por unidad	
10 + 25	11 + 60	13 + 90			

TABURETE DEXTER H6o

Color / Colour / Couleur / Cor:
ROBLE 315 J.C.
Tela / Fabric / Tissu / Tecido:
BRUNEI 41 - S/B FROCA

NEO
LARA



TABURETE
NEO H6o
NEO H8o



TABURETE
NEO MT H6o
NEO MT H8o



TABURETE
LARA H6o
LARA H8o



TABURETE
LARA MT H6o
LARA MT H8o

Con variedad de estilos y alturas el Neo y Lara te aportaran diseño y funcionalidad. Una diseño acompañado de una gran modernidad.

With a variety of styles and heights, the Neo and Lara will provide you with design and functionality. A design accompanied by great modernity.

Avec une variété de styles et de hauteurs, les Neo et Lara vous offriront design et fonctionnalité. Un design accompagné d'une grande modernité.

Com uma variedade de estilos e alturas, o Neo e Lara irão fornecer a você design e funcionalidade. Um design acompanhado de grande modernidade.



TABURETE LARA H6o
Color / Colour / Couleur / Cor:
ROBLE 68o J.C.
Tela / Fabric / Tissu / Tecido:
CAMBOYA 04 - ASIENITO JÚPITER 03 - S/B FROCA

NEO H6o
NEO H8o

NEO MT H6o
NEO MT H8o

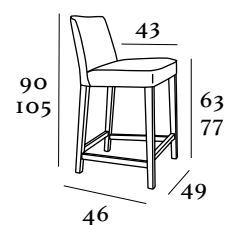
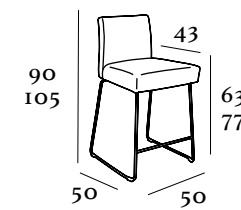

Acabados patas metal
Metal legs finishes



Barnizado, lacado
o color muestra

Varnished, lacquered or sample colour
Vernissage laqué ou couleur de l'échantillon.
Envernizamento, lacagem ou cor da amostra

TC	SA	SB	SC	SD
437	457	477	497	517

	x1 unid.	x1 unid.	x1 unid.	x1 unid.
TABURETE NEO H6o-H8o	1,50 m.	7,5 kg.	10,0 kg.	0,30 m ³
TABURETE NEO MT H6o-H8o	1,50 m.	9,5 kg.	12,0 kg.	0,30 m ³

OPCIONES (en puntos) / OPTIONS (points) / OPTIONS (points) / OPÇÕES (pontos)

- 3 + 0
- 4 + 65
- 5 + 10
Por unidad
- 6 + 25
Por unidad
- 7 + 10
Por unidad
- 9 + 30
- 10 + 25
- 11 + 60
- 13 + 90



TABURETE NEO MT H6o

Color / Colour / Couleur / Cor:
NEGRO EPOXI
Tela / Fabric / Tissu / Tecido:
JUNGLE 84 - S/C M. FARRUGIA

LARA H6o
LARA H8o

LARA MT H6o
LARA MT H8o

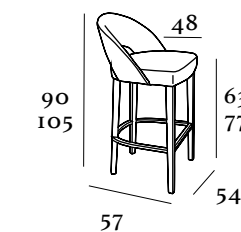
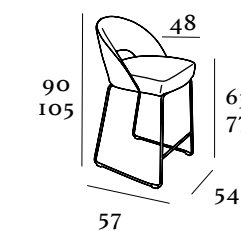

Acabados patas metal
Metal legs finishes



Barnizado, lacado
o color muestra

Varnished, lacquered or sample colour
Vernissage laqué ou couleur de l'échantillon.
Envernizamento, lacagem ou cor da amostra

TC	SA	SB	SC	SD
437	457	477	497	517

	x1 unid.	x1 unid.	x2 unids.	x2 unids.
TABURETE LARA H6o-H8o	1,50 m.	8,5 kg.	12,0 kg.	0,30 m ³
TABURETE LARA MT H6o-H8o	1,50 m.	10,5 kg.	13,0 kg.	0,30 m ³

OPCIONES (en puntos) / OPTIONS (points) / OPTIONS (points) / OPÇÕES (pontos)

- 3 + 0
- 4 + 65



TABURETE LARA MT H6o

Color / Colour / Couleur / Cor:
NEGRO EPOXI
Tela / Fabric / Tissu / Tecido:
CAMBOYA 04 - RESPALDO INT. JÚPITER 03 - S/B FROCA

PRESTON
VIENA



**TABURETE
PRESTON H60
PRESTON H80**



**TABURETE
PRESTON MT H60
PRESTON MT H80**



**TABURETE
VIENA H60
VIENA H80**



**TABURETE
VIENA MT H60
VIENA MT H80**

Preston y Viena ayudará gracias a su gran comodidad que tus veladas sean mas extensas. El placer de su sentada, su diseño y atrevimiento en los tejidos harán que tus velada sean eternas.

Preston and Viena will help thanks to its great comfort that your evenings are more extensive. The pleasure of your sitting, its design and daring in the fabrics will make your evening last forever.

Preston et Viena vous aideront grâce à son grand confort à ce que vos soirées soient plus longues. Le plaisir de votre assise, son design et l'audace des tissus feront durer votre soirée pour toujours.

Preston e Viena ajudarão graças ao seu grande conforto que suas noites sejam mais extensas. O prazer de sentar-se, o seu design e ousadia nos tecidos farão com que a sua noite durar para sempre.



TABURETE VIENA H60
Color / Colour / Couleur / Cor:
VULCANO TEX J.C.
Tela / Fabric / Tissu / Tecido:
GRETA 17 MOSTAZA - VIVO BRUNEI 02 - S/B FROCA

PRESTON H60
PRESTON H80

PRESTON MT H60
PRESTON MTH80

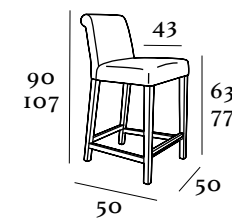
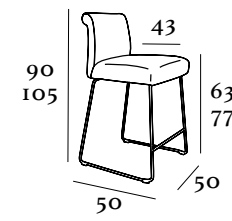

Acabados patas metal
Metal legs finishes



Barnizado, lacado
o color muestra

Varnished, lacquered or sample colour
Vernissage laqué ou couleur de l'échantillon.
Envernizamento, lacagem ou cor da amostra

	TC	SA	SB	SC	SD
	437	457	477	497	517



TABURETE PRESTON H60-H80	1,50 m.	7,5 kg.	10,0 kg.	0,30 m ³
TABURETE PRESTON MT H60-H80	1,50 m.	9,5 kg.	12,0 kg.	0,30 m ³

TABURETE PRESTON H60
Color / Colour / Couleur / Cor:
BLANCO 316 MATE J.C.
Tela / Fabric / Tissu / Tecido:
NAGORE 01 - S/B FROCA

OPCIONES (en puntos) / **OPTIONS** (points) / **OPTIONS** (points) / **OPÇÕES** (pontos)

3 + 0 | 4 + 65 | 5 + 10 | 6 + 25 | 7 + 10 | 9 + 30
 Por unidad | Por unidad | Por unidad

10 + 25 | 11 + 60 | 12 + 240 | 13 + 90



TABURETE PRESTON MT H60
Color / Colour / Couleur / Cor:
CROMO
Tela / Fabric / Tissu / Tecido:
LENNON GRIS - LATERALES Y TRASERA LUCCA 04 S/B C&O - BITEX

VIENA H60
VIENA H80

VIENA MT H60
VIENA MTH80

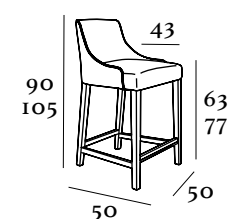
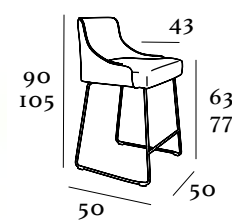

Acabados patas metal
Metal legs finishes



Barnizado, lacado
o color muestra

Varnished, lacquered or sample colour
Vernissage laqué ou couleur de l'échantillon.
Envernizamento, lacagem ou cor da amostra

	TC	SA	SB	SC	SD
	437	457	477	497	517



TABURETE VIENA H60-H80	1,50 m.	7,5 kg.	10,0 kg.	0,30 m ³
TABURETE VIENA MT H60-H80	1,50 m.	9,5 kg.	12,0 kg.	0,30 m ³

TABURETE VIENA H60
Color / Colour / Couleur / Cor:
VULCANO TEX J.C.
Tela / Fabric / Tissu / Tecido:
GRETA 17 MOSTAZA - VIVO BRUNEI 45 - S/B C&O - FROCA

OPCIONES (en puntos) / **OPTIONS** (points) / **OPTIONS** (points) / **OPÇÕES** (pontos)

3 + 0 | 4 + 65 | 5 + 10 | 6 + 25 | 7 + 10 | 9 + 30
 Por unidad | Por unidad | Por unidad

10 + 25 | 11 + 60 | 12 + 240 | 13 + 90



TABURETE VIENA MT H60
Color / Colour / Couleur / Cor:
NEGRO EPOXI
Tela / Fabric / Tissu / Tecido:
PICASSO MOSTAZA - ASIENTO Y VIVO BRUNEI 45 - S/B C&O - FROCA

Puff / Pouff / Pouf / Pouff

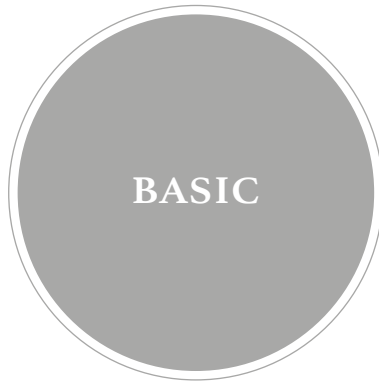

BASIC REDONDO

Tela / Fabric / Tissu / Tecido:

BRUNEI 30 - ASIENTO NORDIC ROSA - S/B C&O - FROCA



BASIC CUADRADO

Tela / Fabric / Tissu / Tecido:

BRUNEI 36 - S/B FROCA

Cuando el tamaño no importa aparecen nuestros puff, los pequeños divertidos, elegantes y cómodos para ofrecer una pequeña isla de confort en cualquier rincón de nuestro hogar.

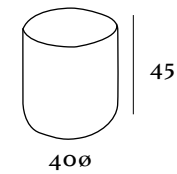

TC	SA	SB	SC	SD
136	155	167	179	199

x1 unid. 1,30 m.	x1 unid. 5,00 kg.	x2 unids. 6,0 kg.	x2 unids. 0,10 m ³
---------------------	----------------------	----------------------	----------------------------------

Lorsque la taille n'a pas d'importance, nos poufs apparaissent, les petits qui sont amusants, élégants et confortables pour offrir un petit îlot de confort dans n'importe quel coin de notre maison.

Quando o tamanho não importa, surgem os nossos pufes, os pequenos que são divertidos, elegantes e confortáveis para oferecer uma pequena ilha de conforto em qualquer recanto da nossa casa.

When size does not matter, our beanbags appear, the small ones that are fun, elegant and comfortable to offer a small island of comfort in any corner of our home.

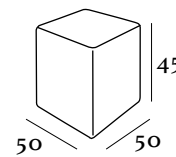

OPCIONES (en puntos) / OPTIONS (points) / OPTIONS (points) / OPÇÕES (pontos)

- 5 + 10
Por unidad
- 6 + 25
Por unidad
- 7 + 10
Por unidad
- 9 + 30
- 11 + 60



COJINES



COJÍN REDONDO
Tela / Fabric / Tissu / Tecido:
BRUNEI 35 - S/B FROCA

Elemento indispensable en todos los hogares, nos dotan de apoyo y confort por los cuatro costados. Combina la tela de tu sofá o silla para conseguir divertidas combinaciones.

An indispensable element in all homes, they provide us with support and comfort on all four sides. Combine the fabric of your sofa or chair to get fun combinations.

Élément indispensable dans tous les foyers, ils nous apportent soutien et confort des quatre côtés. Combinez le tissu de votre canapé ou de votre chaise pour obtenir des combinaisons amusantes.

Elemento indispensável em todas as habitações, proporcionam-nos apoio e conforto nas quatro vertentes. Combine o tecido do seu sofá ou cadeira para obter combinações divertidas.

COJINES



COJÍN CUADRADO
Tela / Fabric / Tissu / Tecido:
LEOPARD 08 / LEOPARD 04 - S/C FROCA



COJÍN RECTANGULAR
Tela / Fabric / Tissu / Tecido:
RINO 18 - S/C FROCA



COJÍN REDONDO
Tela / Fabric / Tissu / Tecido:
ELEPHANT 15 / ELEPHANT 17 - S/C FROCA

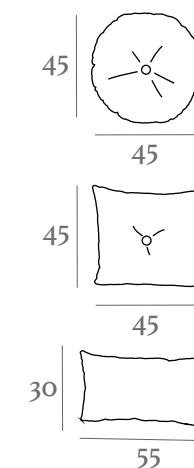

TC	SA	SB	SC	SD
63	70	86	102	118
x1 unid. 0,50 m.	x1 unid. 0,80 kg.	x2 unids. 1,5 kg.	x2 unids. 0,05 m ³	

OPCIONES (en puntos) / OPTIONS (points) / OPTIONS (points) / OPÇÕES (pontos)

5 + 10

Mesa auxiliar en la que destaca su ligereza y funcionalidad. Totalmente personalizable en chapa o color de la madera, para que encaje en el rincón que prefieras.

Side table in which its lightness and functionality stands out. Fully customizable in veneer or wood color, so that it fits in the corner you prefer.

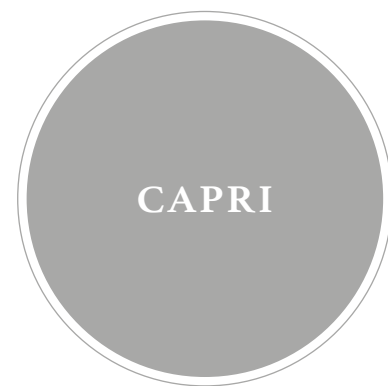
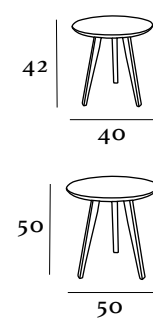

Table d'appoint dans laquelle sa légèreté et sa fonctionnalité se distinguent. Entièrement personnalisable dans la couleur du placage ou du bois, de sorte qu'il s'intègre dans le coin que vous préférez.

Mesa lateral onde se destaca a sua leveza e funcionalidade. Totalmente personalizável em folheado ou cor de madeira, para que caiba no canto que preferir.



CAPRI 40 MESA AUXILIAR
Color / Colour / Couleur / Cor:
ROBLE 680 J.C.

CAPRI 50 MESA AUXILIAR
Color / Colour / Couleur / Cor:
ROBLE 680 J.C.

CHAPAS SHEETS / PLAQUES /CHAPAS	MEDIDAS MEASURES / MESURES /MEDIDAS	BARNIZADO LACADO MATE COLOR MUESTRA VARNISHED MATT LACQUER COLOR SAMPLE	LACADO BRILLO GLOSS LACQUER / LAQUE BRILLANT / LACA BRILHO	CRISTAL GLASS/ VERRE / CRISTAL	KG	BOX	CBM
Haya / Roble / Roble Salvaje / Nugal Americ.	40 Ø	190	+ 95	+ 95	3,0 kg.	5,0 kg.	0,10 m ³
	50 Ø	223	+ 95	+ 95	4,0 kg.	6,0 kg.	0,10 m ³

ASIA SILLÓN
Color / Colour / Couleur / Cor:
ROBLE 680 J.C.
Tela / Fabric / Tissu / Tecido:
THALIS 19 - S/B FROCA

CAPRI 50 MESA AUXILIAR
Color / Colour / Couleur / Cor:
ROBLE 680 J.C.

Elegante a la vez que sencilla. Creada mezclando materiales y acabados que le confieren una sensación de dinamismo sin restarle alto nivel de confort.

Elegant as well as simple. Created by mixing materials and finishes that give it a feeling of dynamism without detracting from the high level of comfort.



Élégant et simple. Créé en mélangeant des matériaux et des finitions qui lui donnent une sensation de dynamisme sans nuire au haut niveau de confort.

Elegante e simples. Criado pela mistura de materiais e acabamentos que lhe conferem uma sensação de dinamismo sem comprometer o elevado nível de conforto.



INDO CENTRO

Color / Colour / Couleur / Cor:

TAPA: BLANCO 316 MATE J.C. - PATAS ROBLE 680 J.C.

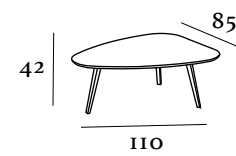

CHAPAS SHEETS / PLAQUES / CHAPAS	MEDIDAS MEASURES / MESURES / MEDIDAS	BARNIZADO LACADO MATE COLOR MUESTRA VARNISHED MATT LACQUER COLOR SAMPLE	LACADO BRILLO GLOSS LACQUER / LAQUE BRILLANT / LACA BRILHO			
Haya / Roble / Roble Salvaje / Nogal Americ.	110x85	498	+ 95	12,5 kg.	15,0 kg.	0,15 m ³



BALI
Color / Colour / Couleur / Cor:
ROBLE 315 J.C.
Tela / Fabric / Tissu / Tecido:
ROCA 78 - TRASERA CUMBRE 09 - S/B C&D

INDO MESA CENTRO
Color / Colour / Couleur / Cor:
BLANCO MATE 316 J.C. - PATAS ROBLE 680 J.C

TEMPO
COMEDOR



HUGO SILLÓN
Color / Colour / Couleur / Cor:
NEGRO 318 MATE J.C.
Tela / Fabric / Tissu / Tecido:
PARADIS BURDEOS - EXT. THALIS 14 - S/B C&O - FROCA

TEMPO COMEDOR - ROBLE NATURAL SALVAJE
Mesa / Table / Table / Mesa
Color / Colour / Couleur / Cor:
ROBLE SALVAJE J.C.
PATAS NEGRO 318 MATE J.C.

TEMPO
CENTRO



VICTORIA
Color / Colour / Couleur / Cor:
VULCANO TEX J.C.
Tela / Fabric / Tissu / Tecido:
ETRO ARENA - S/B C&O

TEMPO CENTRO
Mesa de centro / Coffee table
Table basse / Mesa de centro
Color / Colour / Couleur / Cor:
CHAPA NOGAL AMERICANO
PATAS VULCANO TEX J.C.

SENA
Color / Colour / Couleur / Cor:
VULCANO TEX J.C.
Tela / Fabric / Tissu / Tecido:
LUXE PLATA - VIVO HERMES ANTRACITA S/B C&O

Un sistema de mesa de gran utilidad en cuanto a forma, dimensiones y funcionalidad. La pata incrustada en la estructura le confiere un encanto único.

A very useful table system in terms of shape, dimensions and functionality. The leg embedded in the structure gives it a unique charm.



Un système de table très utile en termes de forme, de dimensions et de fonctionnalité. Le pied noyé dans la structure lui confère un charme unique.

Um sistema de mesa muito útil em termos de forma, dimensões e funcionalidade. A perna embutida na estrutura confere um charme único.



TEMPO COMEDOR - 1 EXT 60 CM.

Mesa / Table / Table / Mesa:
Color / Colour / Couleur / Cor:
ROBLE SALVAJE J.C. PATAS NEGRO MATE 160 X 90

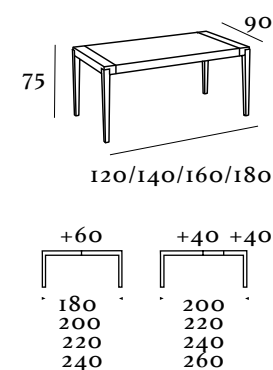

CHAPAS SHEETS / PLAQUES / CHAPAS	MEDIDAS MEASURES / MESURES / MEDIDAS	BARNIZADO LACADO MATE COLOR MUESTRA VARNISHED MATT LACQUER COLOR SAMPLE		LACADO BRILLO GLOSS LACQUER / LAQUE BRILLANT / LACA BRILHO	CRISTAL GLASS / VERRE / CRISTAL	KG	C	M ³
		1 EXT. 60 cm	2 EXT. 40 cm					
Haya Roble Roble Salvaje Nogal Americ.	120X90	1419	1504	+188	+188	56,5 kg.	61,0 kg.	0,25 m ³
	140X90	1441	1521	+188	+188	62,5 kg.	67,0 kg.	0,27 m ³
	160X90	1459	1541	+188	+188	78,5 kg.	73,0 kg.	0,30 m ³
	180X90	1629	1711	+188	+188	84,5 kg.	79,0 kg.	0,35 m ³

Líneas rectas y combinación de chapas y maderas le confieren un carácter neoclásico actualizado completado con la opción de su tapa elevable.

Straight lines and a combination of veneers and woods give it an updated neoclassical character, complete with the option of its lifting top.



Des lignes droites et une combinaison de placages et de bois lui confèrent un caractère néoclassique mis à jour, avec l'option de son plateau relevable.

As linhas retas e a combinação de folheados e madeiras conferem-lhe um carácter neoclássico atualizado, complementado com a opção da sua tampa elevatória.



TEMPO CENTRO 115 X 65 ELEVABLE

Mesa de centro / Coffee table
Table basse / Mesa de centro
Color / Colour / Couleur / Cor:
CHAPA NOGAL AMERICANO
PATAS VULCANO TEX J.C.

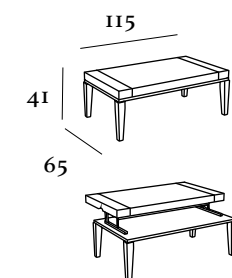

CHAPAS SHEETS / PLAQUES / CHAPAS	MEDIDAS MEASURES / MESURES / MEDIDAS	BARNIZADO LACADO MATE COLOR MUESTRA VARNISHED MATT LACQUER COLOR SAMPLE		LACADO BRILLO GLOSS LACQUER / LAQUE BRILLANT / LACA BRILHO	CRISTAL GLASS / VERRE / CRISTAL	KG	C	M ³
		TAPA ELEVABLE LIFTING TOP / TOP RELEVABLE / TAMP A ELEVÁVEL	TAPA FIJA FIXED TOP / TOP FIXE / TAMP A FIXA					
Haya / Roble / Roble Salvaje / Nogal Americ.	115 x 65 x 41	872	791	+ 95	+ 95	32,0 kg.	36,0 kg.	0,15 m ³

MANHATTAN
COMEDOR



MANHATTAN COMEDOR 160 X 90
Mesa / Table / Table / Mesa
ARENA 853 MATE J.C.
BASE METAL NEGRO EPOXI

OSLO 90 ND SILLA
Color / Colour / Couleur / Cor:
ROBLE 680 J.C.
Tela / Fabric / Tissu / Tecido:
BRUNEI 38 - VIVO BRUNEI 6 - S/B FROCA

MANHATTAN
COMEDOR



Lo primero que llama la atención al contemplarla es su moderno pie central que le confiere atisbos de modernidad sin descuidar la práctica elegancia.

The first thing that catches your eye when contemplating it is its modern central foot that gives it hints of modernity without neglecting practical elegance.

La première chose qui attire votre attention en la contemplant est son pied central moderne qui lui donne des notes de modernité sans négliger l'élégance pratique.

A primeira coisa que chama a atenção ao contemplá-lo é o seu moderno pé central que lhe dá um toque de modernidade sem deixar de lado a elegância prática.

MANHATTAN
COMEDOR



MANHATTAN COMEDOR 160 X 90 - EXT. CENTRAL 60 CM.
Mesa / Table / Table / Mesa
Color / Colour / Couleur / Cor:
ARENA 853 MATE J.C.
BASE METAL NEGRO EPOXI

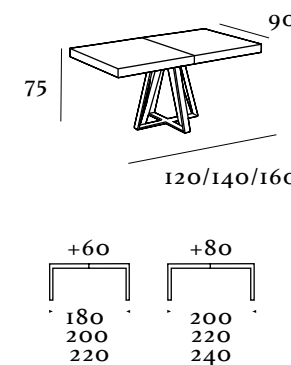

CHAPAS SHEETS / PLAQUES / CHAPAS	MEDIDAS MEASURES / MESURES / MEDIDAS	BARNIZADO LACADO MATE COLOR MUESTRA VARNISHED MATT LACQUER COLOR SAMPLE		LACADO BRILLO GLOSS LACQUER / LAQUE BRILLANT / LACA BRILHO	KG	CUB	M ³
		1 EXT. 60 cm	1 EXT. 80 cm				
Haya Roble Roble Salvaje Nogal Americ.	120X90	1832	1914	+188	76,5 kg.	81,0 kg.	1,00 m ³
	140X90	1854	1936	+188	82,5 kg.	87,0 kg.	0,05 m ³
	160X90	1876	1958	+188	98,5 kg.	93,0 kg.	0,10 m ³

Acabados patas metal
Metal legs finishes
Negro epoxi Blanco epoxi Oro epoxi

PRAGA
COMEDOR

Mesa redonda con pata de madera o pie central. Una elegante estructura le confiere firmeza la caracteriza como una apuesta segura para nuestro hogar.

Round table with wooden leg or central leg. An elegant structure gives it firmness and characterizes it as a safe bet for our home.

Table ronde avec pied en bois ou pied central. Une structure élégante lui donne de la fermeté et le caractérise comme une valeur sûre pour notre maison.

Mesa redonda com perna de madeira ou perna central. Uma estrutura elegante confere-lhe firmeza e a caracteriza como uma aposta segura para a nossa casa.



PRAGA COMEDOR - 110 Ø - 1 EXT 60 CM

Mesa / Table / Table / Mesa

Color / Colour / Couleur / Cor:

BLANCO 316 MATE J.C.

PATAS ROBLE 680 J.C.

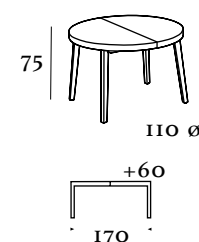

CHAPAS SHEETS / PLAQUES /CHAPAS	MEDIDAS MEASURES / MESURES /MEDIDAS	BARNIZADO LACADO MATE COLOR MUESTRA VARNISHED MATT LACQUER COLOR SAMPLE	LACADO BRILLO GLOSS LACQUER / LAQUE BRILLANT / LACA BRILHO	KG	KG	m ³
		1 EXT. 60 cm LIFTING TOP / TOP RELEVABLE / TAMPA ELEVÁVEL				
Haya / Roble / Roble Salvaje / Nogal Americ.	110 Ø	1444	+ 188	62,5 kg.	67,0 kg.	0,27 m ³



DALIA ND - PATA Nº4 REDONDA
Silla / Chair / Chaise / Cadeira
Color / Colour / Couleur / Cor:
ROBLE 680 J.C.
Tela / Fabric / Tissu / Tecido:
APOLO 61 - S/B C&D

PRAGA COMEDOR - 110 Ø - 1 EXT 60 CM
Mesa / Table / Table / Mesa
Color / Colour / Couleur / Cor:
BLANCO 316 MATE J.C.
PATAS ROBLE 680 J.C.

ATLANTA
COMEDOR

Otra bonita solución para elegir, igualmente con opción de patas o pie central. Seductora, y técnicamente bien acabada, una mesa para toda la vida y para compartir momentos inolvidables.

Another nice solution to choose from, also with a choice of legs or a central base. Seductive, and technically well finished, a table for life and to share unforgettable moments.

Une autre belle solution au choix, également avec un choix de pieds ou d'une base centrale. Séduisante, et techniquement bien finie, une table pour la vie et pour partager des moments inoubliables.

Outra boa solução à sua escolha, também com opção de pernas ou base central. Sedutora e tecnicamente bem acabada, uma mesa para a vida e para partilhar momentos inesquecíveis.



ATLANTA 110 Ø
Mesa / Table / Table / Mesa
Color / Colour / Couleur / Cor:
ROBLE SALVAJE J.C.
BASE METAL NEGRO EPOXI

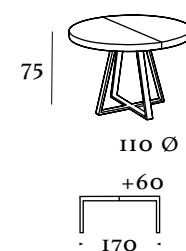

CHAPAS SHEETS / PLAQUES /CHAPAS	MEDIDAS MEASURES / MESURES /MEDIDAS	BARNIZADO LACADO MATE COLOR MUESTRA VARNISHED MATT LACQUER COLOR SAMPLE	LACADO BRILLO GLOSS LACQUER / LAQUE BRILLANT / LACA BRILHO	KG	CUBO	M3
		1 EXT. 60 cm LIFTING TOP / TOP RELEVABLE / TAMPA ELEVÁVEL				
Haya / Roble / Roble Salvaje / Nogal Americ.	110 Ø	1832	+ 188	82,5 kg.	87,0 kg.	0,05 m ³

Acabados patas metal
Metal legs finishes



Negro epoxi Blanco epoxi Oro epoxi



MONACO PMT
Color / Colour / Couleur / Cor:
NEGRO EPOXI
Tela / Fabric / Tissu / Tecido:
FUGI 01 TRASERA ROXY 03 - S/C FROCA

ATLANTA 110 Ø
Mesa / Table / Table / Mesa
Color / Colour / Couleur / Cor:
ROBLE SALVAJE J.C.
BASE METAL NEGRO EPOXI

AREN
COMEDOR

Su diseño atemporal y dinámico la hacen buena candidata casi para todos los ambientes. La posibilidad de combinar la tapa en otros materiales la dotan de gran flexibilidad de ubicación.

Es el concepto con el cual intentamos sintetizar la filosofía de nuestra empresa para la creación de sillas personalizadas. Equilibrio entre imaginación y razón.

Es el concepto con el cual intentamos sintetizar la filosofía de nuestra empresa para la creación de sillas personalizadas. Equilibrio entre imaginación y razón.

Es el concepto con el cual intentamos sintetizar la filosofía de nuestra empresa para la creación de sillas personalizadas. Equilibrio entre imaginación y razón.



AREN COMEDOR 160 X 90 - CHAPA HAYA NATURAL
1 EXT. CENTRAL DE 50 CM
Mesa / Table / Table / Mesa
Color / Colour / Couleur / Cor:
ROBLE 315 J.C.

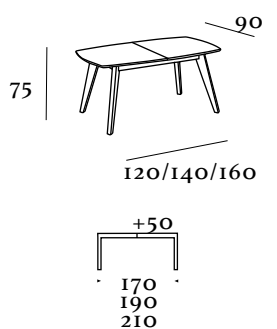

CHAPAS SHEETS / PLAQUES /CHAPAS	MEDIDAS MEASURES / MESURES /MEDIDAS	BARNIZADO LACADO MATE COLOR MUESTRA VARNISHED MATT LACQUER COLOR SAMPLE	LACADO BRILLO GLOSS LACQUER / LAQUE BRILLANT / LACA BRILHO	KG	CUB	M ³
		1 EXT. 50 cm				
Haya	120X90	1277	+188	37,0 kg.	43,0 kg.	0,20 m ³
Roble	140X90	1337	+188	40,0 kg.	45,0 kg.	0,22 m ³
Roble Salvaje Nogal Americ.	160X90	1397	+188	42,0 kg.	47,0 kg.	0,25 m ³



OPCIÓN TAPA RECTANGULAR
AREN R COMEDOR



CATANIA
Color / Colour / Couleur / Cor:
ROBLE 315 J.C.
Tela / Fabric / Tissu / Tecido:
GRETA 16 AZAFATA - ASIENTO ANSEL MARINO - S/B C&O

AREN COMEDOR 160 X 90 - CHAPA HAYA NATURAL
1 EXT. CENTRAL DE 50 CM
Mesa / Table / Table / Mesa
Color / Colour / Couleur / Cor:
ROBLE 315 J.C.

AREN
CENTRO



AREN CENTRO CHAPA ROBLE - 115 X 60 ELEVABLE
Mesa de centro / Coffee table / Table basse / Mesa de centro
Color / Colour / Couleur / Cor:
TAPA ROBLE 68o J.C. PATAS Y
ESTRUCTURA BLANCO MATE J.C.



AREN CENTRO - 115 X 60 ELEVABLE
 Mesa de centro / Coffee table
 Table basse / Mesa de centro
 Color / Colour / Couleur / Cor:
TAPA ROBLE 68o J.C.
PATAS Y ESTRUCTURA BLANCO MATE J.C.

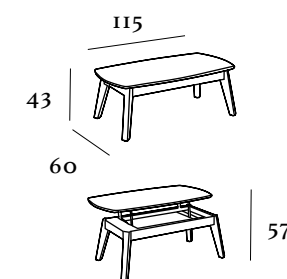

CHAPAS SHEETS / PLAQUES /CHAPAS	MEDIDAS MEASURES / MESURES /MEDIDAS	BARNIZADO LACADO MATE COLOR MUESTRA VARNISHED MATT LACQUER COLOR SAMPLE		LACADO BRILLO GLOSS LACQUER / LAQUE BRILLANT / LACA BRILHO	22,0 kg.	25,0 kg.	0,15 m ³
		TAPA ELEVABLE LIFTING TOP / TOP RELEVABLE /TAMPA ELEVÁVEL	TAPA FIJA FIXED TOP / TOP FIXE /TAMPA FIXA				
Haya / Roble / Roble Salvaje / Nogal Americ.	115X 60 X 43	857	738	+ 95			



OPCIÓN TAPA RECTANGULAR
AREN R CENTRO



Con una estética contemporánea con tintes nórdicos la hacen un complemento ideal en el hogar. Su tapa elevable le confiera mas funcionalidad.

Es el concepto con el cual intentamos sintetizar la filosofía de nuestra empresa para la creación de sillas personalizadas. Equilibrio entre imaginación y razón.

Es el concepto con el cual intentamos sintetizar la filosofía de nuestra empresa para la creación de sillas personalizadas. Equilibrio entre imaginación y razón.

Es el concepto con el cual intentamos sintetizar la filosofía de nuestra empresa para la creación de sillas personalizadas. Equilibrio entre imaginación y razón.

DUBAI
COMEDOR



Su columna vertebral es su propia tapa lo que le confiere estabilidad y versatilidad. Su pata robusta y despuntada dotan a esta mesa de una línea moderna, ligera y actual.

Its spine is its own lid which gives it stability and versatility. Its robust and pointed leg give this table a modern, light and current line.

Sa colonne vertébrale est son propre couvercle, ce qui lui confère stabilité et polyvalence. Son pied robuste et pointu confère à cette table une ligne moderne, légère et actuelle.

A sua lombada é a sua própria tampa o que lhe confere estabilidade e versatilidade. A sua perna robusta e pontiaguda confere a esta mesa uma linha moderna, leve e atual.

DUBAI COMEDOR CHAPA ROBLE NATURAL
- 160 2 EXTENSIONES 40 CM
Mesa / Table / Table / Mesa
Color / Colour / Couleur / Cor:
ROBLE 68o J.C.

CHAPAS SHEETS / PLAQUES /CHAPAS	MEDIDAS MEASURES / MESURES / MEDIDAS	BARNIZADO LACADO MATE COLOR MUESTRA VARNISHED MATT LACQUER COLOR SAMPLE		LACADO BRILLO GLOSS LACQUER / LAQUE BRILLANT / LACA BRILHO	CRISTAL GLASS / VERRE / CRISTAL			
		1 EXT. 60 cm	2 EXT. 40 cm					
Haya Roble Roble Salvaje Nogal Americ.	120X90	1419	1504	+188	+188	56,5 kg.	61,0 kg.	0,25 m ³
	140X90	1441	1521	+188	+188	62,5 kg.	67,0 kg.	0,27 m ³
	160X90	1459	1541	+188	+188	78,5 kg.	73,0 kg.	0,30 m ³
	180X90	1629	1711	+188	+188	84,5 kg.	79,0 kg.	0,35 m ³

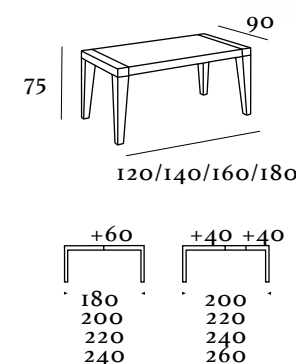

GENOVA XL
Silla / Chair / Chaise / Cadeira
Color / Colour / Couleur / Cor:
ARENA 853 J.C.
Tela / Fabric / Tissu / Tecido:
MADONE BLANCO ROTO - LATERAL MOSAIC o8 - S/B C&O - TURIA

DUBAI COMEDOR CHAPA ROBLE NATURAL
- 160 2 EXTENSIONES 40 CM
Mesa / Table / Table / Mesa
Color / Colour / Couleur / Cor:
ROBLE 68o J.C.

DUBAI
CENTRO



HUGO SILLÓN
Color / Colour / Couleur / Cor:
BLANCO MATE 316 J.C.
Tela / Fabric / Tissu / Tecido:
MAGIA 05 - S/B STILO TEXTIL

DUBAI CENTRO CHAPA ROBLE NATURAL
115X60 ELEVABLE
Mesa de centro / Coffee table
Table basse / Mesa de centro
Color / Colour / Couleur / Cor:
TAPA CENTRAL ROBLE 680 J.C.
PATAS Y PORTERIAS BLANCO MATE J.C.



**DUBAI CENTRO CHAPA ROBLE NATURAL
115x60 ELEVABLE**
Mesa de centro / Coffee table
Table basse / Mesa de centro
Color / Colour / Couleur / Cor:
TAPA CENTRAL ROBLE 68o J.C.
PATAS Y PORTERIAS BLANCO MATE J.C.

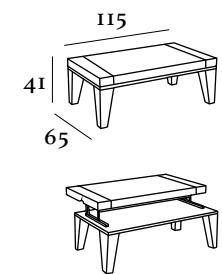

CHAPAS SHEETS / PLAQUES /CHAPAS	MEDIDAS MEASURES / MESURES / MEDIDAS	BARNIZADO LACADO MATE COLOR MUESTRA VARNISHED MATT LACQUER COLOR SAMPLE		LACADO BRILLO GLOSS LACQUER / LAQUE BRILLANT / LACA BRILHO	CRISTAL GLASS / VERRE / CRISTAL			
		TAPA ELEVABLE LIFTING TOP / TOP RELEVABLE / TAMPA ELEVÁVEL	TAPA FIJA FIXED TOP / TOP FIXE / TAMPA FIXA					
Haya / Roble / Roble Salvaje / Nogal Americ.	115 x 65 x 41	872	791	+ 95	+ 95	32,0 kg.	36,0 kg.	0,15 m ³

J. CALVO



Robusta, y también con la pata despuntada como su hermana mayor la mesa de comedor. Es la versión menor de una gran mesa realizada con materiales tradicionales.

Robust, and also with the blunt leg like its older sister the dining table. It is the minor version of a large table made with traditional materials.

Robuste, et aussi avec le pied émoussé comme sa grande sœur la table à manger. C'est la version mineure d'une grande table réalisée avec des matériaux traditionnels.

Robusta, e também com a perna cega como sua irmã maior a mesa de jantar. É a versão secundária de uma grande mesa feita com materiais tradicionais.

BERLIN
COMEDOR



LARA ND - PATA Nº 4 REDONDA
Silla / Chair / Chaise / Cadeira
Color / Colour / Couleur / Cor:
ROBLE 680 J.C.
Tela / Fabric / Tissu / Tecido:
INDIGO 5 - VIVO INDIGO 10 - S/B FROCA

BERLÍN COMEDOR
CHAPA ROBLE SALVAJE NATURAL
160X90 - 1 Ext 60 CM
PATA 12X7 CM
Mesa / Table / Table / Mesa
Color / Colour / Couleur / Cor:
ROBLE SALVAJE J.C.

Diseño sencillo y estilista, su pata cuadrada le confiere una estabilidad que salta a la vista. A pesar de su robustez resulta elegante en cualquier ambiente.

Simple and stylish design, its square leg gives it a stability that is obvious. Despite its robustness, it is elegant in any environment.



De conception simple et stylée, son pied carré lui confère une stabilité qui saute aux yeux. Malgré sa robustesse, il est élégant dans n'importe quel environnement.

Com design simples e elegante, sua perna quadrada confere uma estabilidade óbvia. Apesar de sua robustez, é elegante em qualquer ambiente.



BERLÍN COMEDOR
CHAPA ROBLE SALVAJE NATURAL
160X90 - 1 Ext 60 CM
PATA 12X7 CM
 Mesa / Table / Table / Mesa
 Color / Colour / Couleur / Cor:
ROBLE SALVAJE J.C.

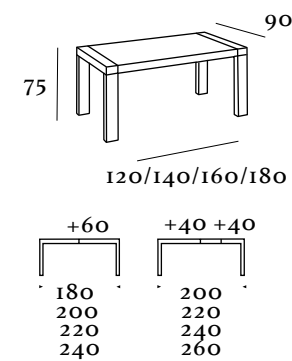

CHAPAS SHEETS / PLAQUES /CHAPAS	MEDIDAS MEASURES / MESURES /MEDIDAS	BARNIZADO LACADO MATE COLOR MUESTRA VARNISHED MATT LACQUER COLOR SAMPLE		LACADO BRILLO GLOSS LACQUER / LAQUE BRILLANT / LACA BRILHO	CRISTAL GLASS / VERRE / CRISTAL	KG	CUBO	M ³
		1 EXT. 60 cm	2 EXT. 40 cm					
Haya Roble Roble Salvaje Nogal Americ.	120X90	1419	1504	+188	+188	56,5 kg.	61,0 kg.	0,25 m ³
	140X90	1441	1521	+188	+188	62,5 kg.	67,0 kg.	0,27 m ³
	160X90	1459	1541	+188	+188	78,5 kg.	73,0 kg.	0,30 m ³
	180X90	1629	1711	+188	+188	84,5 kg.	79,0 kg.	0,35 m ³



SISTEMA DE EXTENSIÓN
EXTENSION SYSTEM
SYSTÈME DE RALLONGE
SISTEMA DE EXTENSÃO



BERLIN
CENTRO



Su tapa elevable aporta soluciones. En la misma línea que Berlín comedor nos encontramos con una robusta mesa de centro, equilibrada funcional.

Its lifting lid provides solutions. In the same vein as Berlin dining room we find a robust coffee table, balanced functional.

Son couvercle relevable apporte des solutions. Dans la même veine que la salle à manger berlinoise on retrouve une table basse robuste, équilibrée fonctionnelle.

Sua tampa de levantamento oferece soluções. Na mesma linha da sala de jantar berlinense encontramos uma mesa de centro robusta, equilibrada e funcional.

DUBAI CENTRO CHAPA ROBLE NATURAL
- 115X65 CM ELEVABLE
PATA 12X7
Mesa de centro / Coffee table
Table basse / Mesa de centro
Color / Colour / Couleur / Cor:
ROBLE CARAMELO J.C.

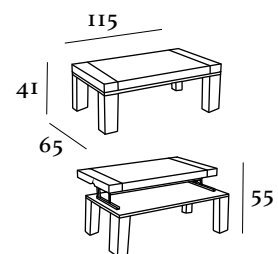

CHAPAS SHEETS / PLAQUES / CHAPAS	MEDIDAS MEASURES / MESURES / MEDIDAS	BARNIZADO LACADO MATE COLOR MUESTRA VARNISHED MATT LACQUER COLOR SAMPLE		LACADO BRILLO GLOSS LACQUER / LAQUE BRILLANT / LACA BRILHO	CRISTAL GLASS / VERRE / CRISTAL	KG	C	M ³
		TAPA ELEVABLE LIFTING TOP / TOP RELEVABLE / TAMP A ELEVÁVEL	TAPA FIJA FIXED TOP / TOP FIXE / TAMP A FIXA					
Haya / Roble / Roble Salvaje / Nogat Americ.	115 x 65 x 41	872	791	+ 95	+ 95	32,0 kg.	36,0 kg.	0,15 m ³



TORINO TM
Silla / Chair / Chaise / Cadeira
Color / Colour / Couleur / Cor:
BEANCO EPOXI
Tela / Fabric / Tissu / Tecido:
OASIS 03 - ASIENTO CAMBOYA 03 - S/B - C FROCA

DUBAI CENTRO CHAPA ROBLE NATURAL
- 115X65 CM ELEVABLE - PATA 12X7
Mesa de centro / Coffee table
Table basse / Mesa de centro
Color / Colour / Couleur / Cor:
ROBLE CARAMELO J.C.

MOSCÚ
COMEDOR



SINTRA
Sillón / Armchair / Fauteuil / cadeira
Color / Colour / Couleur / Cor:
NEGRO EPOXI
Tela / Fabric / Tissu / Tecido:
OASIS 14 ROSA / OASIS 10 MOSTAZA / OASIS 15 AZUL / OASIS 4 GRIS - S/B FROCA

MOSCU COMEDOR CHAPA ROBLE NATURAL
160 2 EXT 40 CM PATA 12X12
Mesa / Table / Table / Mesa
Color / Colour / Couleur / Cor:
ROBLE 68o J.C.



MOSCU COMEDOR CHAPA ROBLE NATURAL
160 x EXT 40 CM PATA 12x12
 Mesa / Table / Table / Mesa
 Color / Colour / Couleur / Cor:
ROBLE 680 J.C.

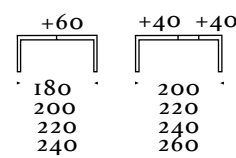
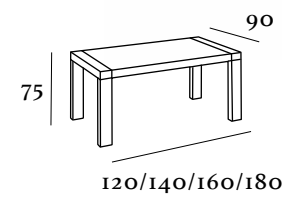

CHAPAS SHEETS / PLAQUES / CHAPAS	MEDIDAS MEASURES / MESURES / MEDIDAS	BARNIZADO LACADO MATE COLOR MUESTRA VARNISHED MATT LACQUER COLOR SAMPLE		LACADO BRILLO GLOSS LACQUER / LAQUE BRILLANT / LACA BRILHO	CRISTAL GLASS / VERRE / CRISTAL			
		1 EXT. 60 cm	2 EXT. 40 cm					
Haya Roble Roble Salvaje Nogal Americ.	120X90	1419	1504	+188	+188	56,5 kg.	61,0 kg.	0,25 m ³
	140X90	1441	1521	+188	+188	62,5 kg.	67,0 kg.	0,27 m ³
	160X90	1459	1541	+188	+188	78,5 kg.	73,0 kg.	0,30 m ³
	180X90	1629	1711	+188	+188	84,5 kg.	79,0 kg.	0,35 m ³



Forma parte de nuestras mesas llamadas "robustas", sus líneas macizadas y su ancha pata cuadrada la dota de una llamativa robustez y confianza.

It is part of our so-called "robust" tables, its solid lines and wide square leg give it a striking robustness and confidence.

Elle fait partie de nos tables dites « robustes », ses lignes pleines et son large pied carré lui confèrent une robustesse et une assurance saisissantes.

Faz parte das nossas mesas ditas "robustas", as suas linhas sólidas e a ampla perna quadrada conferem-lhe uma robustez e uma confiança impressionantes.

MOSCÚ CENTRO

También sigue su estela de su hermana mayor y cumple los mismos objetivos, ahora sí cabe mas acentuados debido a su menor tamaño. Con taba elevable.

It also follows in its wake of its older sister and fulfills the same objectives, now even more accentuated due to its smaller size. With lifting table.

Elle suit également dans le sillage de sa sœur aînée et remplit les mêmes objectifs, désormais encore plus accentués du fait de sa plus petite taille. Avec table élévatrice.

Também segue na esteira da irmã mais velha e cumpre os mesmos objetivos, agora ainda mais acentuados pelo seu tamanho menor. Com mesa elevatória.



MOSCÚ CENTRO
CHAPA NATURAL ROBLE SALVAJE
115 X 65 ELEVABLE - PATA 12X12
 Mesa de centro / Coffee table
 Table basse / Mesa de centro
 Color / Colour / Couleur / Cor:
ROBLE SALVAJE 680 J.C.

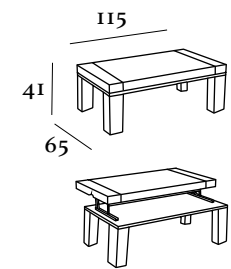

CHAPAS SHEETS / PLAQUES / CHAPAS	MEDIDAS MEASURES / MESURES / MEDIDAS	BARNIZADO LACADO MATE COLOR MUESTRA VARNISHED MATT LACQUER COLOR SAMPLE		LACADO BRILLO GLOSS LACQUER / LAQUE BRILLANT / LACA BRILHO	CRISTAL GLASS / VERRE / CRISTAL	KG	C	M ³
		TAPA ELEVABLE LIFTING TOP / TOP RELEVABLE / TAMPA ELEVÁVEL	TAPA FIJA FIXED TOP / TOP FIXE / TAMPA FIXA					
Haya / Roble / Roble Salvaje / Nogal Americ.	115 x 65 x 41	872	791	+ 95	+ 95	32,0 kg.	36,0 kg.	0,15 m ³



SOFIA
 Color / Colour / Couleur / Cor:
ROBLE 680 J.C.
 Tela / Fabric / Tissu / Tecido:
ZEUS 15 EXTERIOR ROXY 01 - S/B-C FROCA

MOSCÚ CENTRO CHAPA NATURAL ROBLE SALVAJE
115 X 65 ELEVABLE - PATA 12X12
 Mesa de centro / Coffee table
 Table basse / Mesa de centro
 Color / Colour / Couleur / Cor:
ROBLE SALVAJE 680 J.C.

ROMA
COMEDOR

En consonancia con su nombre Roma hace honor a su nombre y a un estilo atemporal. Su pata archipendal es un clásico muy actual.

In keeping with its name, Roma lives up to its name and timeless style. Its archipendal leg is a very current classic.

Fidèle à son nom, Roma est à la hauteur de son nom et de son style intemporel. Son pied archipendal est un classique très actuel.

De acordo com seu nome, Roma faz jus ao seu nome e estilo atemporal. Sua perna arquipendal é um clássico muito atual.



ROMA COMEDOR - 160X90 - 2 EXT 40 CM
Mesa / Table / Table / Mesa
Color / Colour / Couleur / Cor:
LACADO MATE ARENA 680 MATE J.C.
PATAS WENGUE 311 J.C.

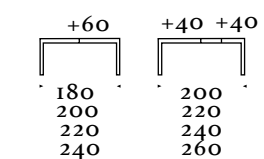
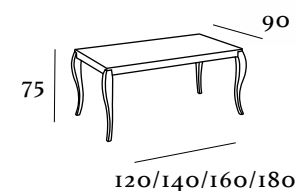

CHAPAS SHEETS / PLAQUES /CHAPAS	MEDIDAS MEASURES / MESURES /MEDIDAS	BARNIZADO LACADO MATE COLOR MUESTRA VARNISHED MATT LACQUER COLOR SAMPLE		LACADO BRILLO GLOSS LACQUER / LAQUE BRILLANT / LACA BRILHO	CRISTAL GLASS / VERRE / CRISTAL	KG	C	M ³
		1 EXT. 60 cm	2 EXT. 40 cm					
Haya Roble Roble Salvaje Nogal Americ.	120X90	1419	1504	+188	+188	56,5 kg.	61,0 kg.	0,25 m ³
	140X90	1441	1521	+188	+188	62,5 kg.	67,0 kg.	0,27 m ³
	160X90	1459	1541	+188	+188	78,5 kg.	73,0 kg.	0,30 m ³
	180X90	1629	1711	+188	+188	84,5 kg.	79,0 kg.	0,35 m ³



VERONA
Color / Colour / Couleur / Cor:
ARENA MATE 853 J.C.
Tela / Fabric / Tissu / Tecido:
FUGI 18 - S/B FROCA - TACHUELA NIQUEL 20 MM

ROMA COMEDOR - 160X90 - 2 EXT 40 CM
Mesa / Table / Table / Mesa
Color / Colour / Couleur / Cor:
LACADO MATE ARENA 680 MATE J.C.
PATAS WENGUE 311 J.C.

ROMA
CENTRO



SOFIA MT
Color / Colour / Couleur / Cor:
NEGRO EPOXI
Tela / Fabric / Tissu / Tecido:
GRETA 05 MENTA - ASIENTO OSLO 06 - S/B C&O - FROCA

ROMA CENTRO CHAPA NATURAL NOGAL AMERICANO
115X65 ELEVABLE
Mesa de centro / Coffee table
Table basse / Mesa de centro
Color / Colour / Couleur / Cor:
NOGAL AMERICANO 348 J.C.
PATAS NEGRO 318 MATE J.C



ROMA CENTRO CHAPA NATURAL NOGAL AMERICANO
115X65 ELEVABLE
 Mesa de centro / Coffee table
 Table basse / Mesa de centro
 Color / Colour / Couleur / Cor:
NOGAL AMERICANO 348 J.C.
PATAS NEGRO 318 MATE J.C

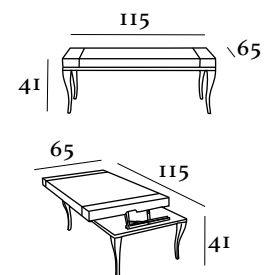

CHAPAS SHEETS / PLAQUES / CHAPAS	MEDIDAS MEASURES / MESURES / MEDIDAS	BARNIZADO LACADO MATE COLOR MUESTRA VARNISHED MATT LACQUER COLOR SAMPLE		LACADO BRILLO GLOSS LACQUER / LAQUE BRILLANT / LACA BRILHO	CRISTAL GLASS / VERRE / CRISTAL			
		TAPA ELEVABLE LIFTING TOP / TOP RELEVABLE / TAMP A ELEVÁVEL	TAPA FIJA FIXED TOP / TOP FIXE / TAMP A FIXA					
Haya / Roble / Roble Salvaje / Nogal Americ.	115 x 65 x 41	872	791	+ 95	+ 95	32,0 kg.	36,0 kg.	0,15 m ³

J. CALVO



La versión menor de Roma, no le quita ni un ápice de protagonismo allá donde vaya colocada, elegancia dentro de la sencillez de líneas donde sus patas siempre marcan la diferencia.

The minor version of Rome does not take away an iota of prominence wherever it is placed, elegance within the simplicity of lines where its legs always make a difference.

La version mineure de Rome n'enlève pas un iota de prééminence où qu'elle soit placée, l'élégance dans la simplicité des lignes où ses jambes font toujours la différence.

A versão menor de Roma não tira um pingão de destaque onde quer que seja colocada, a elegância na simplicidade das linhas onde suas pernas sempre marcam a diferença.

FROCA	BAGDAD A BENICARLO D BIG BLUE COLECC. C BIRMANIA C BORIS C BRUNEI B CAMBOYA C CHANEL B COLORS COLEC. B CRACOVIA C DELHI C DOLCE B EMIKO D ENZO B FAUNA COLECC. D FILA C HOLLYWOOD COLEC. B INDIANA C INDIGO B JUPITER B LANCELOT C LIDO B MACAO B MANGLAR B MIRASOL COLEC B NAGORE B NATURAL COLEC. B OASIS B OSLO COLEC. C PALAMOS D ROLAND A ROXY C SAIKO D TAIPEI B TENNESSEE D THALYS B TITAN B TRENDY COLEC B VOLUTA COLEC. C YOKO D ZEUS B ZOE B	STILO TEXTIL	ACAPULCO B AGUA COLECT. B AISHA B ALLEGRA B ANCONA A ANTONELLA B AROSA B AVANTI B AZAHAR B BIMBA C BLAKE B BRISA B BRISEIDA A CATERINA B CHARLOTTE A CLOE B CONT PLUS ORO D CONT PLUS PLATA D CONTRACT PLUS D CYRO B DANTE A ELEMENT A ELENA A ELOISA A ELSA B ENMA B ENZO A ETNA B EVEREST B EVICE B FANTASIA B FELICITY B FIORI B GINGER B GRACIELA A GREEN B IDIRA A ISOLA B JADE B JULIETTA A KENAI B LETTO LISO C LETTO PUNTO C LUISA B MAGIA B MELODY B MONTECARLO B NATAL B NEWSTAR B NORA A NUBE A	OBOE B OGLIO B ORQUIDEA A OXFORD B PAOLA B PAPIRO B PRENZA B PRESTIGE B ROCIO B SECRET B SELENE B SOFT B STILO B SURF B SYMPHONY B TAMESIS B TEXTURA B TUBA B VELVET A VENUS B VICTORIA B VIENTO A VINTAGE B XIA B	C&O By CABANES & ORTUÑO	ADAM B AIRE B ALEXANDER B ANSEL A AVIA A AYTAMAR A BERGAMO B BIANCA B CALYPSO B CHARLOTTE B CHIARA B CLARET C COBRA Y CAMALEON D COLEC. B GEOMETRICAS B COLEC.LUXURY A ECOPE COLORES B ERMES B ETRO B EXOTIC B FENDY B FIORELLA B GARDEN B GENOVA B GRETA B HABANA B HANSEL B INDIANA B KINOA B LENNON A LIA A LUIGI B MADONE B MAR B MARINA B MONET B OKIOS B PANNA B PAPAGAYO B PARADISE B ROMER B SENA A TEMPLO B TUKI B UNNO B VELVET B VITELLO B	COLORSANE	ARES A ARTE B ASH B AURA A BELLA B CAMELIA B CARISSA B CASSINO B CELIA A COHIBA B CRYSTAL A CUMBIA A DIAMANTE B DIAMON B DOMINICA B DUKE A ECLECTIC B EDA A ELECTRA A ELIXIR B EMILY B FABIO A FAMOUS B FERIT A FIORELLA A GLAMOUR B HEAVEN B LONDON B INKA B ISABELLA B ITALICA B LINA B LIONELLA A LOGAN A LYSSA A MAGNOLIA B MARAVILLA A MELISA A MONACO B NABUT B NEREA B NIDO A NOVA B OPALO B RAMSES B SABLE A TALIA B TORINO A VIOLETTA B WESTER A	elastron HIGHTACHIE	APOLLO C BABEL B BALI B BELLAGIO B BOSTON B BRONX B CAIRO B CARBONO B CORIUM C COWBOY B CRETA C DAKOTA B DANUBIO B DUBAI B DUBLIN C FALCON B FOX B GLASGON C HABANA B HERITAGE B IBIZA C IPANEMA B KENYA B LASER B LISBON B LIVELPOOL B LONDON B MACAO B MADEIRA B MANILA B MAYA B MERITAGE B MILANO B MOZART B MUNICH SUEDE C MUSA B MUSTANG B NAPPA SOFT B NEPAL B NEVADA B OSLO B PACIFICO C PARIS B PEGASUS B ROYAL SUEDE B SAUNA A SUNSET B SUPERSOFT C URUGUAY B VOGUE B
C&D FABRICS	COLECC. ATENAS B COLECC. CITY B COLECC. FECLING B COLECC. RELIEVE B COLECC.FRESH B GREGAL B MISTRAL B	BLEND D CHIC D CLUB D CREDO D DAS D DIVINE D DOLCE-IPM D DROM D DUO D ERBA D GAUDI D IRIS D ITO D LIBRA D ONIX D SACCO D SONNET D SPUTNIK D SUBLIM D TWIN D URUS D VITA-IMP D	ambatex FABRICS	BUITTON COLEC. B COCO COLEC. B HARU COLEC. C LUNA COLEC. B NICO COLEC. B VALERIA COLEC. B ZODIACO COLEC. C	Tapicerías Turia ALBIR B ALTEA B ARAMIL B ARCADIA B BARCIA B BOSTON B CALIBU B CALPE B CANDAS B CANOE B DENIA B ESCARAPELAS B JAVEA B LLANES B MIERES B MODENA B MOSAIC B NADAL B NARCEA B NAVIA B PEREDA B SONORA B SUMO B TREBOL B URDIMBRE COLEC. B	Consultar con fabrica serie y disponibilidad de cualquier otro tejido que no este en el listado. No trabajamos poliétilo o sintéticos salvo en algunos modelos consultar con fabrica.	Check with the factory for the series and availability of any other fabric that is not in the list. We do not work leatherette or synthetics except in some models, check with the factory.	Vérifiez auprès de l'usine pour la série et la disponibilité de tout autre tissu qui ne figure pas dans la liste. Nous ne travaillons pas le similicuir ou le synthétique sauf sur certains modèles, se renseigner auprès de l'usine.	Verifique com a fábrica a série e a disponibilidade de qualquer outro tecido que não esteja na lista. Não trabalhamos em couro sintético ou couro sintético exceto em alguns modelos, consulte a fábrica.	

rioma+	BASALTO D BERSATIL C BOUQUET D BUDAPEST C CAPULETO D CELOSIA D CUBIC D DARVEN D GEN D LOEVE D PARAISO D REBECCA C ROMBO D VELVET PLUS C	Kiero	ANGEL C ATILA C BECKER C BETTY C BLACK B CARIBE C CHAPI C COLORADO B CORDOBA B DAISY B DONNA B FREEDOM B FRESH B GALIA B GOKU B GUESS D HADA C INDO C INVICTUS D JADE C JAIPUR C KISS C LOLA B LUX B MARIOLA C MIU C NORI D NOVENA C OCTAVA C ORIGEN C OUTDOOR C PEPA B POEMA C PRETENCIOSA C SECRETO C SECRETO VIBACC D SEDA B SEGUNDA C SEPTIMA C SEXTA C SIRIA C SKADA B SQUERE C SUMO C TERCERA C TRUFA C TUK C VOLVORETA B	LM	AFRODITA B AQUA B ARIEL B BISONTE B BISONTE METAL B CARMEN B COLORADO B CORDOBA B DAISY B DONNA B FREEDOM B FRESH B INDICO A JENNY B KENYA B LIBERTY B LIFE A LOVE B MARS B MEGA B MITEZZA B NATURE B PARTY A PEOPLE B POINT B TESSERO B VELVETTO B WESTA B	Vicortex	AMBRA C ARIA B ASBESTO B AZABACHE B BALENA B BERLINO B BLENDA B BORAX B CAPRA B CAVIA B CORVO B CRISOL A DELFINO B DUNA B EBRA B FAINA B FALCO B FERRO B FIAMMA B FIORE B FIUME B FLORA A FUOCO B GATTA B ISOLA B LAGO B LUPO B MARE NUVOVA B OPALO B ORSO B PECORA B PIANTA B PIETRA C POLPO B PRESIA B QUADRO B ROCCIA B STAMPA B STUCCHI B TALPA B TROTA B VIPERA B	PIEL	COLECC. FIORE C FIORE C GALIANO C GEO COLEC. C GREENERY COLEC. C MILLENIUM COLEC. C VERONA C	aqua clean TECHNOLOGY	ALHAMBRA C ALPINE C ALTAMURA C AMARAL C ANGORA C BALTIC C BELICE C BELLAGIO C CALEIDO C CAPRICCIO C DAYTONA C FABIA C FANTASY C HYDRA C IMPERIAL C INVICTUSS C KEOPS C LAVIANO C MARINA C MINERVA C MISTYC C MOON C MURIEL C NIRVANA COLEC. B OTARU C ROMANTIC C SAMIRA C STAMFORD C VICTORY C VIVALTO C	Consultar con fabrica serie y disponibilidad de cualquier otro tejido que no este en el listado. No trabajamos poliétilo o sintéticos salvo en algunos modelos consultar con fabrica.	Check with the factory for the series and availability of any other fabric that is not in the list. We do not work leatherette or synthetics except in some models, check with the factory.	Vérifiez auprès de l'usine pour la série et la disponibilité de tout autre tissu qui ne figure pas dans la liste. Nous ne travaillons pas le similicuir ou le synthétique sauf sur certains modèles, se renseigner auprès de l'usine.	Verifique com a fábrica a série e a disponibilidade de qualquer outro tecido que não esteja na lista. Não trabalhamos em couro sintético ou couro sintético exceto em alguns modelos, consulte a fábrica.
Bitex	ALHAMAR B AQUILES B BABALOO B BANUS B BIL B GRAPPA B LUCCA B NIKI B SOL B TIVOLI B WAIKIKI B	ALONSO MERCADER	CONSULTAR CON FÁBRICA	VD	ANGEL C AURORA D AVANT C BELLAR VELUET C CHARLOTT C COMFOR D CORONA D CUMBIA C DIAMANTE C FABIO D GRANADA C HERMES C JAGUAR D KONGO C LICOLIN C NATURE C OMAN D PALLADIUM C PALMIRA C RAMSES C SALVADOR C TRENDY D TWIST C VENUS C VICTORIA C VIENTO C	SPRADLING GROUP INC.	PURE D SILVERTEX D								

I PATAS / LEGS / PIEDS / PATAS

MADERA DE HAYA / BEECH WOOD / BOIS DE HÊTRE / MADEIRA DE FAIA

- Para cualquiera de nuestros productos que sea posible esta opción
- For any of our products which this option is possible
- Pour tous nos produits où cette option est possible
- Para qualquer um dos nossos produtos, esta opção é possível



P1 + 0 P2 P3 P5

P4 + 33

P4 delantera y trasera / front and back / avant et arrière / dianteiro e traseiro
Redondeada / rounded / arrondi / arredondado

2 OPCIÓN SILLÓN / ARMCHAIR OPTION
OPTION FAUTEUIL / OPÇÃO DE CADEIRÃO + 95

MEDIDA SILLÓN
ARMCHAIR MEASURE
MESURE FAUTEUIL
DE MEDIDA POLTRONA:

Alto
Height
Hauteur
Alto

66,5 cm

Ancho
width
Largeur
largura

56 cm

BRAZOS DISPONIBLES / ARMS AVAILABLES / BRAS DISPONIBLES / BRAÇOS DISPONÍVEIS:



01 02 03 07 08

No varía la pata
Legs do not change
Le pied ne change pas
A pata não varia

- Cualquier modificación de altura consultar con fábrica
- Check with the factory for changes in height
- Pour toute modification en hauteur, consulter le fabricant.
- Qualquer modificação de altura, consulte a fábrica

3 COMBINACION TEJIDOS
COMBINATIONS OF FABRIC / COMBINAISONS DE TISSU
COMBINAÇÃO DE TECIDOS + 0

- Para combinaciones consultar metraje con fábrica
- For combinations, check measures with the factory
- Pour les combinaisons, vérifier les mesures avec l'usine
- Para combinações, verifique as medidas com a fábrica

- Cuando se combinen 2 telas diferentes se calculará el precio de la superior

- When 2 different fabrics are combined, the price of the superior one will be calculated
- Lorsque 2 tissus différents sont combinés, le prix du supérieur sera calculé
- Quando 2 tecidos diferentes são combinados, o preço do superior será calculado



4 TACHUELAS / STUDS / PUNAISES / TACHASPATAS

12 mm. Ø + 65

20 mm. Ø + 65



Bronce Plata vieja Niquel Oro

5 BOTONES / BUTTONS / BOUTONS / BOTOENS

20 mm. Ø + 10

35 mm. Ø



20 mm. Ø 35 mm. Ø

6 CRISTALES SWAROVSKY / SWAROVSKY CRYSTAL
/ SWAROVSKY CRISTAUX / CRISTAIS SWAROVSKI

23 mm. Ø + 25

Unidad
Unit
Unité
Unit



7 TIRÓN / PULL / ÉLONGATION / PUXÃO + 10



8 ASIENTO TAPIZADO / UPHOLSTERED SEAT
ASSISE TAPISSÉ / ASSENTO ESTOFADO + 25

TELA 2 SILLAS
FABRIC 2 CHAIRS
TISSU 2 CHAISE
TECIDO 2 CADEIRAS

+ 0,30 m



9 VIVO / PIPING / PASSEPOIL / VIVO + 30

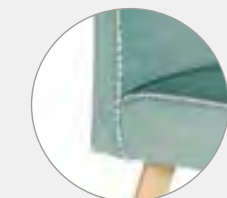

10 COSTURAS DECORATIVAS / DECORATIVE SEAMS
/ COUTURES DÉCORATIVES / COSTURA DECORATIVA + 25

- Indicar en el pedido el color del hilo, si no se indica se fabricará al tono del tejido.
- Indicate in the order the colour of the thread, if it is not indicated it will be made in the tone of the fabric.
- Indiquer sur la commande la couleur du fil; sans ce, nous fabriquerons dans la couleur du tissu.
- Indique na ordem que a cor da linha, se não for indicada, será fabricada de acordo com o tom do tecido.



CRUZ MIX LINE

11 FALSO CAPITONÉ / CAPITONÉ FALSE
FALSE CAPITONNÉ / FALSE CAPITONÉ + 60



12 OPCIÓN CAPITONÉ
/ CAPITONÉ OPTION / OPTION CAPITONNÉ / OPÇÃO CAPITONÉ



COLECCIÓN MADERA
WOOD COLLECTION
COLLECTION BOIS
COLEÇÃO DE MADEIRA

+ 140



COLECCIÓN TAPIZADO
UPHOLSTERED COLLECTION
COLLECTION TAPISSÉE
COLEÇÃO ESTOFADA

+ 240

+ 0,30 m.

AUMENTO METRAJE TELA PARA
CUALQUIER MODELO CON CAPITONÉ
INCREASE FABRIC METRATION FOR ANY
MODEL WITH CAPITONE
AUGMENTEZ LA METRAGE DU TISSU POUR
TOUT MODÈLE AVEC CAPITONE
AUMENTE A METRAÇÃO DE TECIDO PARA
QUALQUER MODELO COM CAPITONE

13 ANILLA DECORATIVA / DECORATIVE HANDLE
POIGNÉE DÉCORATIVE / ANÉIS DECORATIVOS + 90

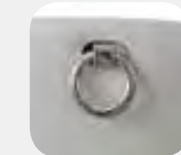

14 GIRATORIOS / SWIVELS
PIVOTANTS / GIRATÓRIOS + 0



GND

+ 125

180°
Retorno

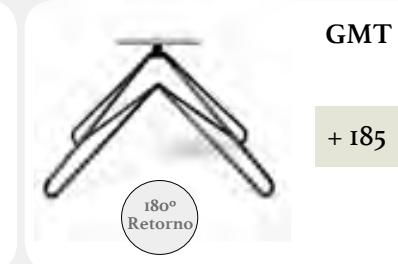

GMT

+ 185

180°
Retorno

ACABADOS PATAS METAL
METAL LEGS FINISHES
FINITIONS PIEDS MÉTAL
ACABAMENTOS DE PERNAS DE METAL

NEGRO EPOXI BLANCO EPOXI
CROMO ORO EPOXI

15 PMT - PATA METÁLICA TUBO / METALLIC TUBE LEG / PIED
EN TUBE MÉTALLIQUE / PÉ DE TUBO METÁLICO + 0



+ 0

NEGRO EPOXI BLANCO EPOXI
CROMO ORO EPOXI

16 ND - PATA NÓRDICA / NORDIC LEG / PIED NORDIQUE
/ PÉ NORDICA



ND + 0

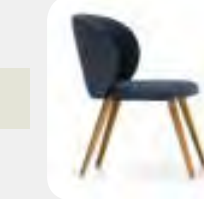

NDP4 + 33

Redondeada / rounded
/ arrondi / arredondado

17 MT - PATÍN METÁLICO / METALLIC LEG / PIED MÉTALLIQUE
/ PÉ METÁLICO + 0



+ 0

NEGRO EPOXI BLANCO EPOXI
CROMO ORO EPOXI

ESTRUCTURA INTERIOR MACHIMBRADA



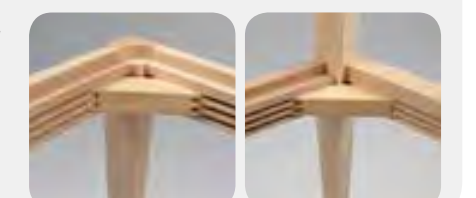





















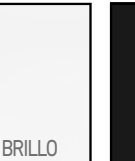

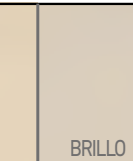



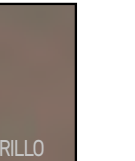

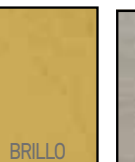

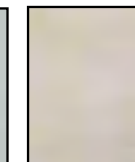

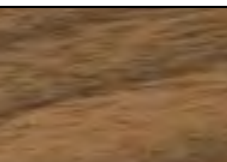
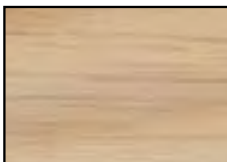
MACHIMBRATED INSIDE STRUCTURE
STRUCTURE INTÉRIEURE MACHINE
ESTRUTURA INTERIOR
MACHIMBRADA

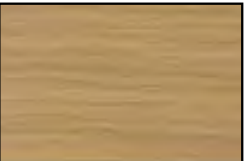
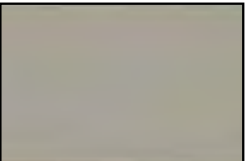

COLORES DE FABRICANTES / MANUFACTURER COLORS / COULEURS DU FABRICANT / CORES DO FABRICANTE

ÁGORA	EXPORMIN	LA CABAÑA	MUÑOZ Y VILLARREAL
BAIXMODULS	F. FRANCO	LLASS	NACHER
CASADO	FRESMOBIL	LOYRA	NOGAL YECLA
CASANOVA Y GANDÍA	GANOVAS	MESEGUE	PEMI
CIURANS	GARCÍA SABATER	METACRILUC	PIÑERO Y CABRERO
COIN	GILSAN	MOBELCHUECA	RAMIRO TARAZONA
COSTERA	GRUPO HUERTAS	MOBENIA	RIMOBEL
CREACIONES S.S.	GRUPO SEYS	MOBIL FRESNO	SANCHEZ VAZQUEZ
DISEMOBEL	HERESSHOME	MONRABAL Y CHIRIVELLA	TENDENCIAS MARÍN
DISENIA	HURTADO	MOPRIMSA	TORGA
ECO-PIN	INDESAN	MUEBLES DE LA ABUELA	UTRILLA
EDICIÓN MOBILIARIO	ISABELO MADRID	MUGALI	VIVE
ELIZANA	KIARE	MUJEBLES EXOJO	

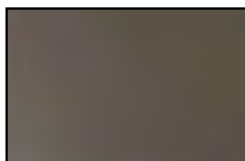
BARNICES Y LACADOS / VARNISHES AND LACQUERS / VERNIS ET LAQUES / VERNIZES E LACAS

											
300	301	302	303	304	305	306					
											
307	308	309	310	311	312	313					
											
314	315	316	317	318	319	320	321	322	323	324	325
											
326	327	328	329	330	331	332	335	336	337-1	337-2	
											
338-1	338-2	339-1	339-2	345	348	ROBLE 680	ARENA 853	NV-349			
		<p>La madera es una materia viva, única e irreplicable en sí misma, debido a esto sus tonalidades y vetas variarán ligeramente. El colorido de los productos que aparecen en este catálogo, puede variar ligeramente debido al proceso de impresión.</p> <p>The wood is a living, and unique material, for this reason the shades and grains could vary slightly. The colour of the products shown in this catalogue could vary slightly because of the printing process.</p> <p>Le bois est un matériau vivant, unique et irremplaçable en lui-même, les teintes et les veines peuvent varier légèrement. La couleur des produits qui apparaissent dans ce catalogue peuvent varier légèrement dû au processus d'impression.</p> <p>A madeira é um material vivo, único e irrepetível por si só, por isso suas tonalidades e veias irão variar um pouco. A cor dos produtos que aparecem neste catálogo pode variar ligeiramente devido ao processo de impressão.</p>									
VT-350	ROBLE CARAMELO										

J. CALVO 

J. CALVO 

J. CALVO SILLERIA S.L 2015
Ctra. de Jumilla, Km. 1,6 - 30510 YECLA (Murcia) SPAIN
T: +34 968 71 82 42 - F: +34 968 71 82 43
info@jcalvosilleria.com
www.jcalvosilleria.com

